



# ARCHITECTURAL WINDOW AND DOOR SYSTEMS

<b>CITYVIEW™ 101.6MM SLIDING WINDOW.....</b>	<b>40</b>
101.6mm Sliding Window Sections .....	41
101.6mm Sliding Window Sections - Single Piece.....	47
Sliding Window Hardware .....	49
System Tooling.....	53
<b>CITYVIEW™ 101.6MM DOUBLE HUNG WINDOW .....</b>	<b>54</b>
Double Hung Window - Single Glazed Sections.....	55
Commercial Double Hung - Single & Double Glazed .....	56
101.6mm Double Hung Window Sections.....	57
Double Hung Window Hardware.....	60
Commercial Double Hung Window Hardware.....	61
System Tooling.....	64
<b>CITYVIEW™ AWNING &amp; CASEMENT WINDOW.....</b>	<b>66</b>
35mm Awning & Casement Window Sections.....	67
50mm Awning & Casement Window Sections.....	69
Truth / Awning Window Sections.....	70
W.A. Awning Window Sections.....	70
Awning & Casement Window Hardware.....	71
<b>HARBOURVIEW™ MULTIFOLD DOOR SYSTEM .....</b>	<b>78</b>
Standard Flushbolt Multifold Door.....	79
Brio Flushbolt Multifold Door .....	81
Brio Bottom Rolling Multifold Door.....	82
Single Glazed Multifold Door .....	83
Double Glazed Multifold Door .....	84
Top Rolling Multifold Door Hardware .....	85
Bottom Rolling Multifold Door Hardware.....	86
Multifold Door Hardware .....	87
System Tooling.....	100
<b>CITYVIEW™ PATIO DOOR SYSTEM.....</b>	<b>102</b>
101.6mm Patio Door .....	103
165mm Patio Door .....	106

Patio Door Sections .....	107
Patio Door Sections - Single Piece .....	111
Patio Door Hardware .....	114
System Tooling.....	119
<b>CITYVIEW™ ARCHITECTURAL SLIDING DOOR SYSTEM .....</b>	<b>120</b>
101.6mm Architectural Sliding Door .....	121
152.4mm Architectural Sliding Door .....	127
203.2mm Architectural Sliding Door .....	131
Architectural Sliding Door Sections.....	132
Architectural Sliding Door Sections - High Performance ....	136
Architectural Sliding Door Hardware .....	137
<b>DOOR SECTIONS .....</b>	<b>144</b>
35mm Door Sections.....	145
45mm Door Sections - Standard .....	146
45mm Door Sections - Open Pocket.....	149
45mm Door Sections - Open Pocket Double Glazed.....	151
45mm Door Sections - Flush Face .....	153
45mm Door Sections - Double Beaded Door.....	154
Commercial Door Tracks .....	156
Door Section Hardware .....	158
Hinges .....	159
Door Closers.....	160
Locks - Commercial .....	162
Door Section Hardware .....	167
System Tooling.....	169
<b>LOUVRE WINDOWS.....</b>	<b>170</b>
Manually Operated Louvre Windows.....	171
Cityview™ 101.6mm Louvre System.....	177
<b>KLASSICVIEW™ RESIDENTIAL WINDOW &amp; DOOR SYSTEMS..</b>	<b>180</b>
Residential Window & Door Systems.....	180
Complete Knocked-Down-Kits (KDK).....	181





## 101.6mm SLIDING WINDOW

### 101.6MM SLIDING WINDOW (INCLUDING SINGLE PIECE INTERLOCK)

GLASS THICKNESS	CHANNEL RUBBER REQUIRED	POCKET SIZE
6mm	1670	12.5mm
8mm	1604	
10mm	1671	
12mm	1666	21.5mm
16mm	1689	
18mm	1667	
20mm	1677	
20.4mm	1661	



# 101.6MM SLIDING WINDOW SECTIONS

**CODE**      **DESCRIPTION**      **LGTH**      **FINISH**      **GROUP ID**

SW001	Head  1721	5.3m	M/F CL/ANOD	10601 10602	
-------	--	------	----------------	----------------	---

SW002	Snap In Head Fits with TJ302  1721	5.3m	M/F CL/ANOD	10601 10602	
-------	---	------	----------------	----------------	---

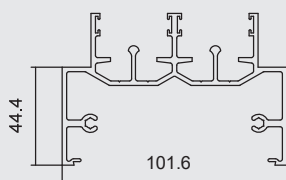





SW003	Open Sill  1721	5.3m	M/F CL/ANOD	10601 10602	
-------	---	------	----------------	----------------	---

SW004	Closed Sill (Slotted) Fits with TJ304  1721, 1685	5.3m	M/F CL/ANOD	10601 10602	
-------	--	------	----------------	----------------	---

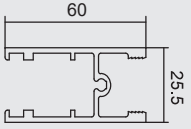
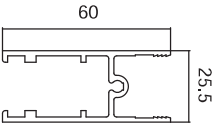
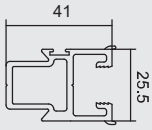
SW007	Single Glazed Rail	5.3m	M/F CL/ANOD	10601 10602	
-------	--------------------	------	----------------	----------------	---

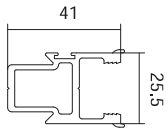

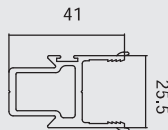

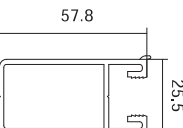
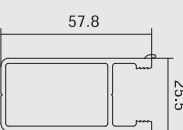
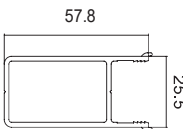
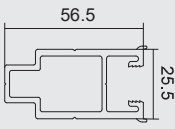
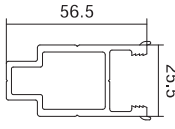
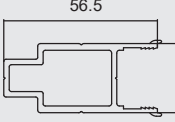





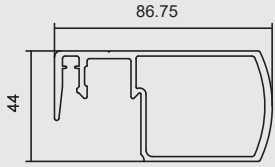

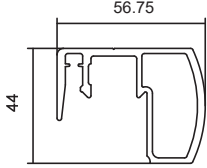
 Key hardware.

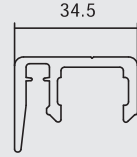
# 101.6MM SLIDING WINDOW SECTIONS

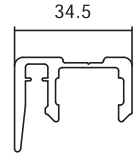
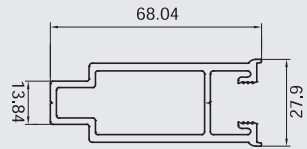
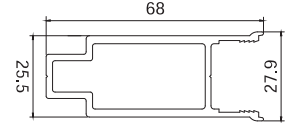
	CODE	DESCRIPTION		LGTH.	FINISH	GROUP ID
	SW008	Double Glazed Rail Suits 16mm Glass	<b>TO BE DISCONTINUED</b>	5.3m	M/F CL/ANOD	10601 10602
	SW026	Double Glazed Rail Up to 20mm Glass		6.5m	M/F CL/ANOD	10801 10802
	SW009	Single Glazed Interlock Stile Fits with SW014/015/016  1721	<b>TO BE DISCONTINUED</b>	4.6m	M/F CL/ANOD	10601 10602
				5.4m		
	SW010	Double Glazed Interlock Stile Suits 16mm Fits with SW014/015/016  1721	<b>TO BE DISCONTINUED</b>	4.6m	M/F CL/ANOD	10601 10602
				5.4m		
	SW027	Double Glazed Interlock Stile Up to 20mm Glass Fits with SW014/015/016  1721		5.4m	M/F CL/ANOD	10801 10802
	SW011	Single Glazed Lock Stile	<b>TO BE DISCONTINUED</b>	4.6m	M/F CL/ANOD	10601 10602
				5.4m		
	SW012	Double Glazed Lock Stile Suits 16mm Glass	<b>TO BE DISCONTINUED</b>	4.6m	M/F CL/ANOD	10601 10602
				5.4m		
	SW028	Double Glazed Lock Stile - Up to 20mm Glass		5.4m	M/F CL/ANOD	10801 10802
	SW022	Single Glazed Male Stile	<b>TO BE DISCONTINUED</b>	5.4m	M/F CL/ANOD	10801 10802
				4.6m		
	SW023	Double Glazed Male Stile - Up to 16mm Glass	<b>TO BE DISCONTINUED</b>	4.6m	M/F CL/ANOD	10601 10602
				5.4m		
	SW029	Double Glazed Meeting Stile - Up to 20mm Glass		5.4m	M/F CL/ANOD	10801 10802

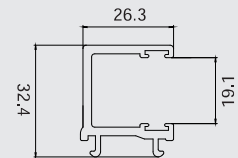
 Key hardware.

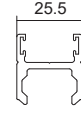

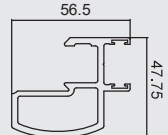



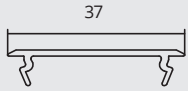
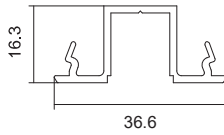
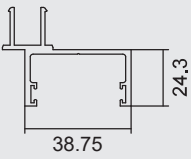

# 101.6MM SLIDING WINDOW SECTIONS

CODE	DESCRIPTION	LGTH.	FINISH	GROUP ID	
SW015	Heavy Interlock  1672, 1832	4.6m	M/F CL/ANOD	10601 10602	
		5.4m	M/F CL/ANOD	10801 10802	
SW014	Medium Interlock  1672, 1831	4.6m	M/F CL/ANOD	10601 10602	
		5.4m	M/F CL/ANOD	10801 10802	
SW016	Standard Interlock  1672, 1830	4.6m	M/F CL/ANOD	10601 10602	
		5.4m	M/F CL/ANOD	10801 10802	
SW025	Interlock To Suit Vent-Lock  1272, 1672	4.6m	M/F CL/ANOD	10601 10602	
SWD044	Patio Corner Stile – Male	5.4m	M/F	10801	
SWD045	Patio Corner D/G Stile – Male - Up to 20mm Glass	4.5m	M/F	10801	
SWD623	Corner Meeting Stile  1721, 1842	5.4m	M/F	10801	
SW024	Female Adaptor Fits with SW009 / SW010  1721	4.6m	M/F CL/ANOD	10601 10602	
		5.4m	M/F CL/ANOD	10801 10802	
SW013	Sliding Window Medium Duty Female Adaptor  1721	4.6m	M/F CL/ANOD	10601 10602	

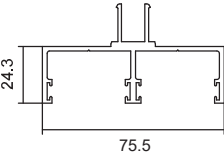
TO BE DISCONTINUED - including 1272

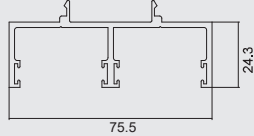

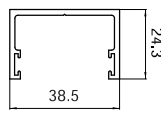

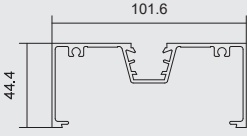
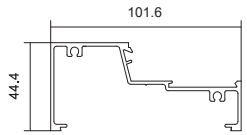
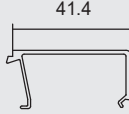
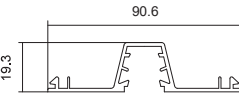





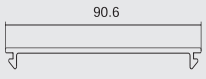
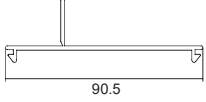
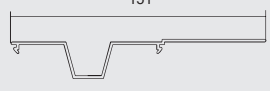
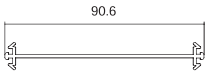

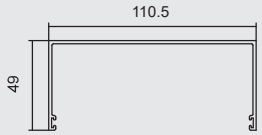

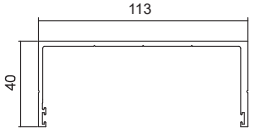

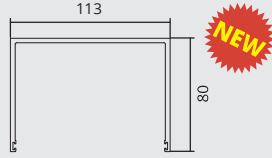
 Key hardware.

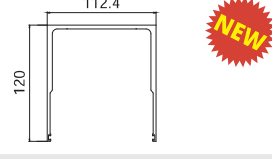
# 101.6MM SLIDING WINDOW SECTIONS

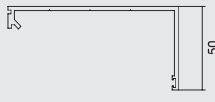
	CODE	DESCRIPTION	LGTH.	FINISH	GROUP ID
	SW019	Threshold	5.3m	M/F CL/ANOD	10601 10602
			6.5m	M/F CL/ANOD	10801 10802
	SW020	Flyscreen Adaptor Fits with SW018	4.6m	M/F CL/ANOD	10601 10602
	SW017	Single Receiver Channel Fits with TJ301  1721	4.6m	M/F CL/ANOD	10601 10602
	SW018	Double Receiver Channel Fits with TJ301  1721	4.6m	M/F CL/ANOD	10601 10602
	SW035	Sliding Window Receiver Channel for Centred Double Glazed  1721	4.6m	M/F CL/ANOD	10601 10602
	SWD035	Plant on Receiver Channel  1721	6.5m	M/F CL/ANOD	10801
	TJ301	Standard Main Frame Fits with TJ304/305/306/342/307/ SW017/SW018	6.5m	M/F CL/ANOD BZ/ANOD	8301 8302 8301
	TJ302	Sill Transom Fits with TJ303/304/305	6.5m	M/F CL/ANOD BZ/ANOD	8301 8302 8301
	TJ303	Sill Bead Fits with TJ302	6.5m	M/F CL/ANOD BZ/ANOD	8301 8302 8301
	TJ304	Glazing Adaptor Fits with TJ301/302/306/307/308/335/ TJ6151/6152	6.5m	M/F CL/ANOD BZ/ANOD	8301 8302 8301

 Key hardware.

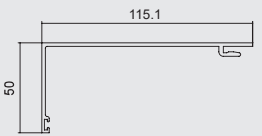
# 101.6MM SLIDING WINDOW SECTIONS

CODE	DESCRIPTION	LGTH.	FINISH	GROUP ID	
TJ305	Flush Adaptor Fits with TJ301/302	6.5m	M/F CL/ANOD BZ/ANOD	8301 8302 8301	
TJ342	Reveal Clip-In Fits with TJ301/302	6.5m	M/F CL/ANOD	8301 8302	
TJ345	Fixing Adaptor Fits with TJ301	5.4m	M/F	8301	
TJ385	Back To Back Adaptor	6.5m	M/F	8301	
TJ309	49mm Sub Head  1601, 1710	6.5m	M/F CL/ANOD BZ/ANOD	10001 10002 10001	
TJ399	Heavy Duty Sub Head  1601, 1710	6.5m	M/F CL/ANOD	10001 10002	
TJ692	80mm Sub Head  1601, 1710	6.5m	M/F CL/ANOD	10001 10002	
TJ520	120mm Sub Head  1601, 1710	6.5m	M/F	10001 10002	
TJ430	Two Part Sub Head Fits with TJ429  1601	6.5m	M/F CL/ANOD	10001 10002	
TJ429	Sub Head Cover Fits with TJ430  1601	6.5m	M/F CL/ANOD	10001 10002	
TJ431	Standard Two Part Subhead / Jamb Fits with TJ6159  1601	6.5m	M/F CL/ANOD	10001 10002	
TJ6159	Sub Head / Jamb Cover Fits with TJ431  1601	6.5m	M/F CL/ANOD	10001 10002	

 Key hardware.



# 101.6MM SLIDING WINDOW SECTIONS











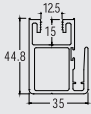

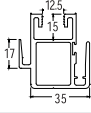

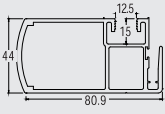

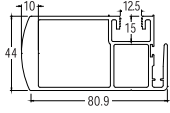

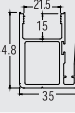
	CODE	DESCRIPTION	LGTH.	FINISH	GROUP ID
	TJ359	Light Duty Sub Sill 12mm Set Back Slotted 1601, 1930	6.5m	M/F CL/ANOD BZ/ANOD	10001 10002 10001
	TJ368	Standard Sub Sill 6mm Set Back Slotted 1601, 1930	6.5m	M/F CL/ANOD	10001 10002
	TJ379	Heavy Duty Sub Sill 12mm Set Back Slotted 1601, 1930	6.5m	M/F CL/ANOD	10001 10002
	TJ259	Sub Sill 25mm Set Back Slotted 1601, 1930	6.5m	M/F CL/ANOD BZ/ANOD	10001 10002 10001
	TJ432	Sub Sill 35mm Set Back Slotted 1601, 1930	6.5m	M/F CL/ANOD	10001 10002
	TJ370	Sub Sill with Reveal 1601, 1925	6.5m	M/F	8301
	TJ479	High Performance Sub Sill 22mm Set Back Slotted 1601	6.5m	M/F CL/ANOD	10001 10002

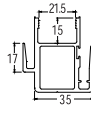
**TO BE  
DISCONTINUED**

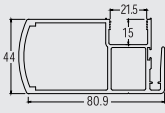
Key hardware.

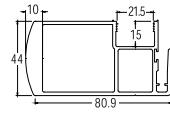

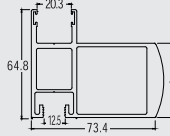
CityView™ • 101.6mm Sliding Window

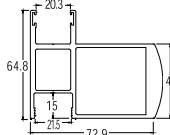
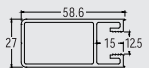
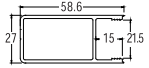
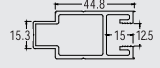
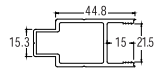
# 101.6MM SLIDING WINDOW SECTIONS - SINGLE PIECE

CODE	DESCRIPTION	LGTH.	FINISH	GROUP ID	
SWD050	Single Interlock Stile Single Glazed  1672, 1721, 1847, 1848	5.4m	M/F CL/ANOD	10802	
SWD051	Single Interlock with Fly Stile Single Glazed  1672, 1721, 1847, 1848	5.4m	M/F CL/ANOD	10802	
SWD052	Single Interlock Box Stile Single Glazed  1672, 1721, 1847, 1848, 1849	5.4m	M/F CL/ANOD	10802	
SWD053	Single Interlock H/D Box Stile Single Glazed  1672, 1721, 1847, 1848, 1849	5.4m	M/F CL/ANOD	10802	
SWD060	Single Interlock Stile Double Glazed  1672, 1721, 1847, 1848	5.4m	M/F CL/ANOD	10802	
SWD061	Single Interlock with Fly Stile Double Glazed  1672, 1721, 1847, 1848	5.4m	M/F CL/ANOD	10802	
SWD062	Single Interlock Box Stile Double Glazed  1672, 1721, 1847, 1848, 1849	5.4m	M/F CL/ANOD	10802	
SWD063	Single Interlock H/D Box Stile Double Glazed  1672, 1721, 1847, 1848, 1849	5.4m	M/F CL/ANOD	10802	
SWD055	H/D Female Adapter Single Glazed  1672, 1721, 1849	5.4m	M/F CL/ANOD	10802	
SWD065	H/D Female Adapter Double Glazed  1672, 1721, 1849	5.4m	M/F CL/ANOD	10802	
SWD056	Stile Single Glazed	5.4m	M/F CL/ANOD	10802	
SWD066	Stile Double Glazed	5.4m	M/F CL/ANOD	10802	
SWD057	Male Stile Single Glazed	5.4m	M/F CL/ANOD	10802	
SWD067	Male Stile Double Glazed	5.4m	M/F CL/ANOD	10802	

 Key hardware.

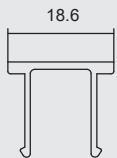
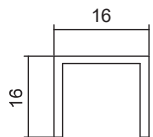
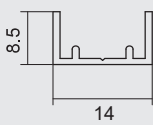
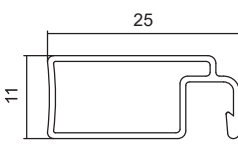
# 101.6MM SLIDING WINDOW SECTIONS - SINGLE PIECE

	CODE	DESCRIPTION	LGTH.	FINISH	GROUP ID
	TJ307	Flush Pocket Filler Fits with TJ301/304	6.5m	M/F CL/ANOD BZ/ANOD	8301 8302 8301
	DT3355	Jamb Flyscreen Channel	6.5m	M/F CL/ANOD	2210 2210
	DT3553	Interlock Flyscreen Channel	6.5m	M/F CL/ANOD	2210 2210
	HFF180	Extruded Fly Frame 25 x 11mm  2680, 1850	5.0m	M/F CL/ANOD	2210 2210



 Key hardware.

# SLIDING WINDOW HARDWARE

CODE	DESCRIPTION	U.O.M.	BOX QTY.	GROUP ID	
1600	Bulb Seal PVC - 250m Roll	Roll	1	16169	
1601	Bulb Seal Co-Extruded	Roll	N/A	16169	
1670	Glazing Channel To Suit 6.38mm Glass - 100m Roll	Roll	N/A	16169	
1604	Glazing Channel To Suit 8.38mm Glass - 100m Roll	Roll	N/A	654	
1671	Glazing Channel To Suit 10.38mm Glass - 100m Roll	Roll	N/A	16169	
1666	Glazing Channel To Suit 12.38mm Glass - 40m Roll	Roll	N/A	16109	
1689	Glazing Channel To Suit 16mm Glass - 60m Roll	Roll	N/A	16169	
1667	Glazing Channel To Suit 18mm Glass - 80m Roll	Roll	N/A	16109	
1677	Glazing Channel To Suit 20mm Glass - 80m Roll	Roll	N/A	16169	
1661	Glazing Channel To Suit 20.4mm Glass - 80m Roll	Roll	N/A	16169	
1672	Interlock Cushion - 100m Roll	Roll	N/A	16173	
1685	Sill Flap / Insert - 300m Roll	Roll	N/A	16169	
1685-COEX	Sill Flap / Insert Co-Extruded - 200m Roll	Roll	1	16169	
1721	Weatherstrip 67-525 Black with Fin - 400m Roll	Roll	5	16173	
2642	Foam Seal - Slide in - 500m Roll	Roll	N/A	16177	
1850	Fly Screen Springs	Each	100	6155	
1925	Sill Flap - 200m Roll	Roll	N/A	16169	

# SLIDING WINDOW HARDWARE

	CODE	DESCRIPTION	U.O.M.	BOX QTY.	GROUP ID
	1804	Window Wheel - 40kg	Each	100	16109
	1800	Anthony Innovations 9017NA Roller for Single Wheel Patio Door - 40kg	Each	100	16149
	1801	Anthony Innovations 9017DNA Roller for Dual Wheel Patio Door - 80kg	Each	100	16149
	1833	Fixing Clip to Suit Sliding Window Interlock - Bag of 500	Bag	5000	16109
	1836	Fixing Clip to Suit Patio Interlock - Bag of 500	Bag	N/A	16109
	1834	Hole Plug 10mm - Bag of 200	Bag	N/A	16109
	1912	Setting Block / Fixed Panel Spacing Block 10mm - Bag of 500	Bag	N/A	16157
	1963	Universal Stop Suits Sliding Window & Double Hung Window - Bag of 20	Bag	N/A	17320
	1964	Universal Sliding Window Stop Packer - Bag of 20	Bag	N/A	17320
	1965	Adjustable Anti-lift Block	Pair	N/A	17320
	1830	Filler Block for SW016 - Bag of 20	Bag	N/A	16109
	1831	Filler Block for SW014 Bag of 10 Pairs	Bag	N/A	16109
	1832	Filler Block for SW015 Bag of 10 Pairs	Bag	N/A	16109

# SLIDING WINDOW HARDWARE

CODE	DESCRIPTION	U.O.M.	BOX QTY.	GROUP ID	
1842	Patio Corner Door Block (L & R)	10 pairs p/bag	N/A	16109	
1485	Foam Seal - 695 Pieces Roll Fits with SW001/002/003	Roll	N/A	16177	
1847	Single Interlock Fixed Panel Block SWD050/51/52/53/60/61/62/63	10 pairs p/bag	N/A	16109	
1848	Single Interlock Filler Block SWD050/51/52/53/60/61/62/63	10 pairs p/bag	N/A	16109	
1849	Single Interlock End Cap SWD052/53/55/62/63/65	10 pairs p/bag	N/A	16109	
1270	Doric Keyed Lock - Black	Each	100	16109	
1271	Keyed Sliding Window Lock - Black  1273,1276	Each	100	16109	
1274	Slimline Sliding Window Lock - Black  1271,1273	Each	N/A	16109	
1273	Sliding Window Barron Lock - 2mm Packer  1271	Each	100	16109	
1276	3mm Packer for Strike on the Cityview Barron Locks Suits 1271/1274	Each	N/A	16109	
1267.**	Pearl Sliding Window Lock, Keyed Alike Key #7010  **Specify finish: Black-BL, Silver-SCA	Each	10	16109	
1272	Sliding Window Vent Lock Keyed 	Each	N/A	16109	
2680	Corner Stake to Suit HFF180 (Plastic)	Each	500	6152	
1990	Sill Plug (Black) - 60 Plugs & 20 Slotted	80 pieces p/bag	N/A	16109	

 Key hardware.

# SLIDING WINDOW HARDWARE

	CODE	DESCRIPTION	U.O.M.	BOX QTY.	GROUP ID
	1900-M	Frame Packers - 1.5mm X 90mm Blue 100/Bag	Bag	N/A	16157
	1901-M	Frame Packers - 3mm X 90mm Green 100/Bag	Bag	N/A	16157
	1902-M	Frame Packers - 5mm X 90mm Ochre 100/Bag	Bag	N/A	16157
	1903-M	Frame Packers - 10mm X 90mm Black 100/Bag	Bag	N/A	16157
	1910	Setting Blocks 3mm Thick - Bag of 1,000	Bag	N/A	16157
	1911	Setting Blocks 5mm Thick - Bag of 1,000	Bag	N/A	16157
	1912	Setting Blocks 10mm Thick - Bag of 500	Bag	N/A	16157
	1977	Setting Blocks 5mm X 25mm - 3m Self Adhesive - Bag of 200	Bag	N/A	17320
	1978	Setting Blocks 10mm X 25mm - 3m Self Adhesive - Bag of 200	Bag	N/A	17320
	1979	Setting Blocks 3mm X 10mm X 25mm - 3m Double Sided Tape - Bag of 200	Bag	N/A	17320
	1930	End Cap To Suit Subsills Bag of 50 Pairs ( <i>Left &amp; Right</i> )	Bag	N/A	16157
	1960	Lanotec General Purpose Liquid Lanolin 400g	Tube	12	16181
	1961	Lanotec "Citra Force" Cleaner Degreaser 400g	Tube	12	16181



Please check with your local branch for stock availability.

# SYSTEM TOOLING

**CODE**      **DESCRIPTION**

DTL3106      101.6mm Sliding Window / Patio Door Drilling Jig  
Suits SW009/010/011/012/022/023



DTL3107      Stepped Drill Bit  
To Suit DT3106 Jig



DTL3110-  
AIR      Sliding Window / Patio Door Air Operated Tool



DTL3112      101.6m Patio Door & Sliding Window Jamb Tool



DTL3116      101.6m Sliding Window Jamb Drill Jig



DTL3124      Single Piece Sliding Window / Patio Door Air Tool







## 101.6mm DOUBLE HUNG WINDOW

DOUBLE HUNG WINDOW		
GLASS THICKNESS	CHANNEL RUBBER REQUIRED	POCKET SIZE
4mm	1923	12.5mm
5mm	1924	
6mm	1670	
8mm	1604	
10mm	1671	
12mm	1666	21.5mm
16mm	1689	
18mm	1667	
20mm	1677	





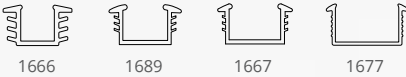





1923 1924 1670 1604 1671

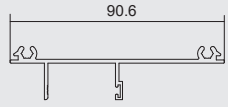

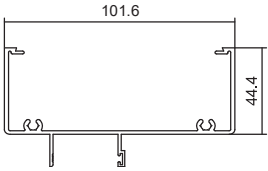
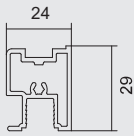
1666 1689 1667 1677

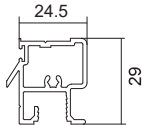

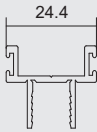
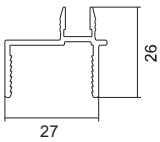
# DOUBLE HUNG WINDOW - SINGLE GLAZED SECTIONS

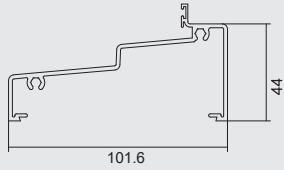
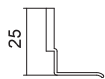
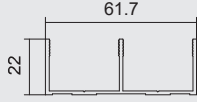
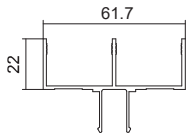
CODE	DESCRIPTION		LGTH.	FINISH	GROUP ID	
DH107	Snap In Head Fits with TJ302  1714	<b>TO BE DISCONTINUED</b>	6.5m	M/F CL/ANOD	10701 10702	
DH109	Head  1714		6.5m	M/F CL/ANOD	10701 10702	
DH110	Rail		6.5m	M/F CL/ANOD	10701 10702	
DH111	Interlock  1715		6.5m	M/F CL/ANOD	10701 10702	
DH114	Sash  1705		6.5m	M/F CL/ANOD	10701 10702	
DH116	Double Hung Double Glazed Adaptor		6.5m	M/F CL/ANOD	10701 10702	
DH112	Sill  1714		6.5m	M/F CL/ANOD	10701 10702	
DH115	High Performance Sill Adaptor Fits with DH112		6.5m	M/F CL/ANOD	10701 10702	
DH113	Jamb Screw Fix		6.5m	M/F CL/ANOD	10701 10702	
DH108	Snap In Jamb Fits with TJ301		6.5m	M/F CL/ANOD	10701 10702	







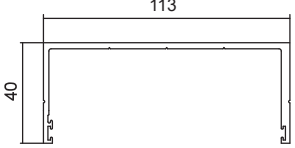

 Key hardware.

# COMMERCIAL DOUBLE HUNG - SINGLE & DOUBLE GLAZED

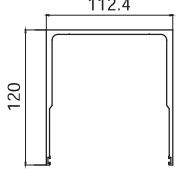
	CODE	DESCRIPTION	LGTH.	FINISH	GROUP ID
	DH242	Single Glazed Interlock Stile 1936	4.6m	M/F CL/ANOD	10702
	DH252	Interlock Rail 20mm Pocket 1928, 1936	4.6m	M/F	10701
	DH243	Single Glazed Interlock Stile 1675, 1895, 1936	4.6m	M/F CL/ANOD	10702
	DH253	Interlock Rail 20mm Pocket 1675, 1895, 1936	4.6m	M/F	10701
	DH245	Single Glazed Rail	4.6m	M/F CL/ANOD	10702
	DH255	Stile 20mm Pocket	4.6m	M/F	10701
	DH248	Single Glazed Sash Stile 1675	4.6m	M/F CL/ANOD	10702
	DH258	Sash Stile 20mm Pocket 1675	4.6m	M/F	10701
	DH117	Screw Fix Jamb Adaptor 1936	6.5m	M/F CL/ANOD	8301 8302 8301
	DH256	Sill Enclosed 1926, 1936	6.5m	M/F CL/ANOD	10702
	TJ301	Standard Main Frame Fits with TJ304/305/306 TJ307/335	6.5m	M/F CL/ANOD BZ/ANOD	8301 8302 8301
	TJ302	Sill Transom Fits with DH107	6.5m	M/F CL/ANOD BZ/ANOD	8301 8302 8301
	TJ303	Sill Bead Fits with TJ302	6.5m	M/F CL/ANOD BZ/ANOD	8301 8302 8301
	TJ304	Glazing Adaptor Fits with TJ301/302/DH112	6.5m	M/F CL/ANOD BZ/ANOD	8301 8302 8301

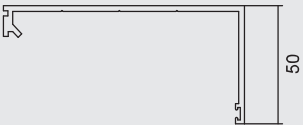

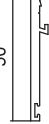







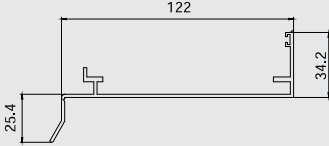

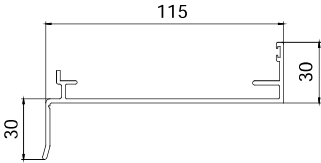

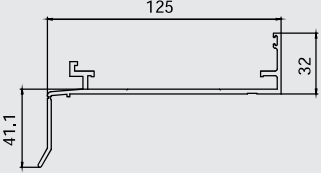
Key hardware.

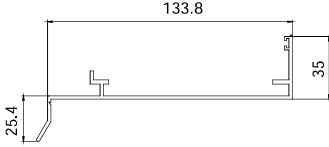
# 101.6MM DOUBLE HUNG WINDOW SECTIONS

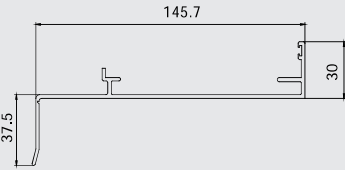
CODE	DESCRIPTION	LGTH.	FINISH	GROUP ID	
TJ309	49mm Sub Head  1601, 1710	6.5m	M/F CL/ANOD BZ/ANOD	10001 10002 10001	
TJ399	Heavy Duty Sub Head  1601, 1710	6.5m	M/F CL/ANOD	10001 10002	
TJ692	80mm Sub Head  1601, 1710	6.5m	M/F CL/ANOD	10001 10002	
TJ520	120mm Sub Head  1601, 1710	6.5m	M/F	10001 10002	
TJ430	Two Part Sub Head Fits with TJ429  1601	6.5m	M/F CL/ANOD	10001 10002	
TJ429	Sub Head Cover Fits with TJ430  1601	6.5m	M/F CL/ANOD	10001 10002	
TJ431	Standard Two Part Subhead / Jamb Fits with TJ6159  1601	6.5m	M/F CL/ANOD	10001 10002	
TJ6159	Cover Fits with TJ431  1601	6.5m	M/F CL/ANOD	10001 10002	

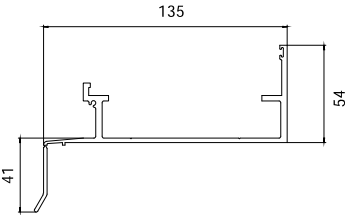
 Key hardware.

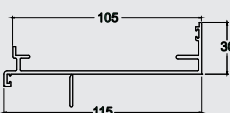
# 101.6MM DOUBLE HUNG WINDOW SECTIONS



	CODE	DESCRIPTION	LGTH.	FINISH	GROUP ID
	TJ359	Light Duty Sub Sill 12mm Set Back Slotted  1601, 1930	6.5m	M/F CL/ANOD BZ/ANOD	10001 10002 10001
	TJ368	STD Sub Sill 6mm Set Back Slotted  1601, 1930	6.5m	M/F CL/ANOD	10001 10002
	TJ379	Heavy Duty Sub Sill 12mm Set Back Slotted  1601, 1930	6.5m	M/F CL/ANOD	10001 10002
	TJ259	Sub Sill 25mm Set Back Slotted  1601, 1930	6.5m	M/F CL/ANOD BZ/ANOD	10001 10002 10001
	TJ432	Sub Sill 35mm Set Back Slotted  1601, 1930	6.5m	M/F CL/ANOD	10001 10002
	TJ479	High Performance Sub Sill 22mm Set Back Slotted  1601	6.5m	M/F CL/ANOD	10001 10002
	TJ370	Sub Sill with Reveal  1601, 1925	6.5m	M/F	8301

TO BE  
DISCONTINUED

 Key hardware.

CityView™ • 101.6mm Double Hung Window

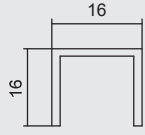
# 101.6MM DOUBLE HUNG WINDOW SECTIONS

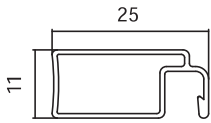
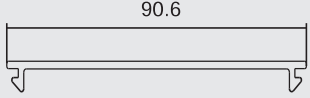
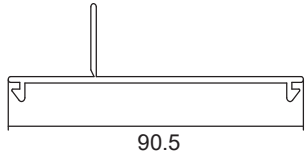
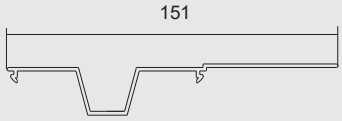
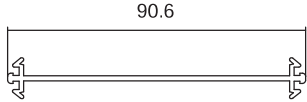
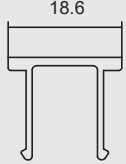
CODE	DESCRIPTION	LGTH.	FINISH	GROUP ID	
DT3355	Jamb Flyscreen Channel	6.5m	M/F CL/ANOD	2211 2212	
HFF180	Extruded Fly Frame 25 x 11mm  2680, 1850	5.0m	M/F CL/ANOD	8301 8302	
TJ305	Flush Adaptor Fits with TJ301/302	6.5m	M/F CL/ANOD BZ/ANOD	8301 8302 8301	
TJ342	Reveal Clip-In Fits with TJ301/302	6.5m	M/F CL/ANOD	8301 8302	
TJ345	Fixing Adaptor Fits with TJ301	5.4m	M/F CL/ANOD	8301 8302	
TJ385	Back to Back Adaptor	6.5m	M/F CL/ANOD	8301 8302	
TJ307	Flush Pocket Filler Fits with TJ301/304	6.5m	M/F CL/ANOD BZ/ANOD	8301 8302 8301	







 Key hardware.

# DOUBLE HUNG WINDOW HARDWARE

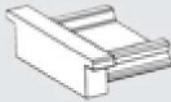
	CODE	DESCRIPTION	U.O.M.	BOX QTY.	GROUP ID
	1275	Double Hung Accessory Package <i>Note: Springs Are "Non Stocked" Request Order Sheet from Customer Service.</i>	Set	N/A	16105
	1470	Foam Seal - Suits 101.6mm Double Hung Head (Set: L&R), 455 Sets on a Roll	Roll	N/A	16177
	1471	Foam Seal - Suits 101.6mm Double Hung Sill (Set: L&R), 475 Sets on a Roll	Roll	N/A	16177
	2280-**	Whitco Keyed Double Hung Lock Suits DH111 <i>**Specify finish: Black-BL, Satin Chrome-SC.</i>	Each	10	6131
	2281	Double Hung Lock Keeper - Suits 2280, S/Steel	Each	50	16105
	1690	Glazing Channel To Suit Double Hung 4mm Glass - 80m Roll	Roll	N/A	16169
	1691	Glazing Channel To Suit Double Hung 5mm Glass - 100m Roll	Roll	N/A	16169
	1692	Glazing Channel To Suit Double Hung 6mm Glass - 150m Roll	Roll	N/A	16169

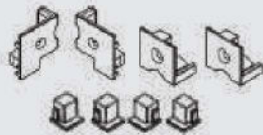
 Please check with your local branch for stock availability.

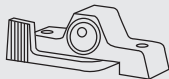
# COMMERCIAL DOUBLE HUNG WINDOW HARDWARE

CODE	DESCRIPTION	U.O.M.	BOX QTY.	GROUP ID	
1472	Foam Seal - 1050 Pieces Roll Suits 101.6mm Centre Glazed Single	Roll	1	16177	
1474	Foam Seal - 1050 Pieces Roll Suits 100mm Front Glazed Single	Roll	1	16177	
1837	End Cap to Suit Patio Door Threshold - Black	20 pieces p/bag	N/A	16109	
1850	Fly Screen Springs	Each	100	6155	
1891	Double Hung Window Blocks & Guides	Bag	5 sets/bag	16105	
1895	Interlock Blocks	Bag	20 sets/bag	17320	
1928	Double Hung Cam Sash Suits DH242/252	Each	Each	17320	
1929	Double Hung Friction Foot	Bag	Set of 4	16105	
2680	Corner Stake to Suit HFF180 (Plastic)	Each	500	6152	



Please check with your local branch for stock availability.



# COMMERCIAL DOUBLE HUNG WINDOW HARDWARE

	CODE	DESCRIPTION	U.O.M.	BOX QTY.	GROUP ID
	1923	4mm Glazing Channel - 80m Roll	Roll	N/A	16169
	1924	5mm Glazing Channel - 100m Roll	Roll	N/A	16169
	1670	Glazing Channel To Suit 6.38mm Glass - 100m Roll	Roll	N/A	16169
	1604	Glazing Channel To Suit 8.38mm Glass - 100m Roll	Roll	N/A	654
	1671	Glazing Channel To Suit 10.38mm Glass - 100m Roll	Roll	N/A	16169
	1666	Glazing Channel To Suit 12.38mm Glass - 40m Roll	Roll	N/A	16109
	1689	Glazing Channel To Suit 16mm Glass - 60m Roll	Roll	N/A	16169
	1667	Glazing Channel To suit 18mm Glass - 75m Roll	Roll	N/A	16169
	1677	Glazing Channel To Suit 20mm Glass - 80m Roll	Roll	N/A	16169
	1601	Bulb Seal Co-Extruded	Roll	N/A	16169
	1705	Weatherstrip 48-525 Black - 500m Roll	Roll	5	16173
	1714	Weatherstrip 48-625 Black - 450m Roll	Roll	5	16105
	1715	Weatherstrip 48-850 Black - 350m Roll	Roll	5	16105
	2642	Foam Seal - Slide in - 500m Roll	Roll	N/A	16177
	1926	Drain Flap - 300m	Roll	N/A	16169

 Please check with your local branch for stock availability.

# DOUBLE HUNG WINDOW HARDWARE

CODE	DESCRIPTION	U.O.M.	BOX QTY.	GROUP ID
1900-M	Frame Packers - 1.5mm X 90mm Blue 100/Bag	Bag	N/A	16157
1901-M	Frame Packers - 3mm X 90mm Green 100/Bag	Bag	N/A	16157
1902-M	Frame Packers - 5mm X 90mm Ochre 100/Bag	Bag	N/A	16157
1903-M	Frame Packers - 10mm X 90mm Black 100/Bag	Bag	N/A	16157
1906	Aluminium Frame Packers 1mm 100/Bag	Bag	N/A	6149
1907	Aluminium Frame Packers 2mm 100/Bag	Bag	N/A	6149
1908	Aluminium Frame Packers 5mm 100/Bag	Bag	N/A	6149
1909	Aluminium Frame Packers 10mm 100/Bag	Bag	N/A	6149
1910	Setting Blocks 3mm Thick - Bag of 1,000	Bag	N/A	16157
1911	Setting Blocks 5mm Thick - Bag of 1,000	Bag	N/A	16157
1912	Setting Blocks 10mm Thick - Bag of 500	Bag	N/A	16157
1977	Setting Blocks 5mm X 25mm - 3m Self Adhesive	Bag	N/A	17320
1978	Setting Blocks 10mm X 25mm - 3m Self Adhesive	Bag	N/A	17320
1979	Setting Blocks 3mm X 10mm X 25mm - 3m Double Sided Tape	Bag	N/A	17320
1930	End Cap To Suit Subsills Bag of 50 Pairs - Left + Right	Bag	N/A	16157
1943	53mm Double Hung Bottom Stops - Black	Bag	N/A	17320
1960	Lanotec General Purpose Liquid Lanolin 400g	Tube	12	16181
1961	Lanotec "Citra Force" Cleaner Degreaser 400g	Tube	12	16181
1963	Window Spring Cover Stops - Bag of 20	Bag	N/A	17320

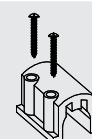
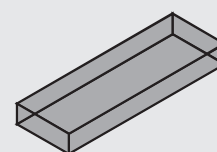

Please check with your local branch for stock availability.

# SYSTEM TOOLING

	CODE	DESCRIPTION	U.O.M.	BOX QTY	GROUP ID
	DTL3126	Commercial Double Hung Tool Suits DH24/25	Each	N/A	N/A

	DTL3104	Double Hung Drilling Jig for Springs Suits DH108/113	Each	N/A	N/A
--	---------	--	------	-----	-----

	DTL3105	Double Hung Drilling Jig Suits DH109/112	Each	N/A	N/A
---	---------	--	------	-----	-----



**CityView™** • 101.6mm Double Hung Window

# SPECIAL FEATURE



## NEW GUILLOTINE & BRAKE PRESS MACHINES

### *Now available in Darley's Victorian Office*

Darley is pleased to announce that the new aluminium guillotine and brake press machines are now in operation in the Darley Victorian office.

The guillotine machine cuts the aluminium sheets to size and the brake press machine folds & bends the sheets. Both machines have the capabilities to handle lengths of up to 3.6m sheets and a sheet thickness of 1.2mm to 4mm. We also offer the option of **In-house Powder Coating** for all aluminium sheets. Contact your Account Manager or local Darley branch to find out more.

Guillotine Machine	
Type of Sheet	Flat aluminium sheets cut to size
Lengths	Up to 3.6m sheets
Sheet Thickness	From 1.2mm to 4mm

Brake Press Machine	
Lengths	Up to 3.6m sheets
Sheet Thickness	From 1.2mm to 4mm
Types of Folds	Made to size: <ul style="list-style-type: none"><li>• Top hat</li><li>• Angles</li><li>• Z shape flashings</li></ul>





## AWNING & CASEMENT WINDOW

### 35 AWNING SASHES FOR TJ722, TJ723 & TJ724

GLASS THICKNESS	WEDGE REQUIRED	TAPE REQUIRED	BEAD REQUIRED
6mm	1620 OR 1601	1452	TJ709
8mm	1630 OR 1601	1451	
10mm	1630 OR 1601	1450	
12mm	1615	1452	TJ713
	1620	1453	
16mm	1620	1451	
	1630	1452	
18mm	1630	1450	
20mm	1615	1453	TJ016
22mm	1615	1452	
	1601	1453	
24mm	1620	1452	
	1601	1453	

### 50 AWNING SASH FOR TJ741 & TRUTH SASH





GLASS THICKNESS	WEDGE REQUIRED	TAPE REQUIRED	BEAD REQUIRED
6mm	1931	1451	TJ714
8mm	1623	1450	
10mm	1615	1451	
12mm	1620	1450	
16mm	1931	1451	TJ716
18mm	1931	1450	
20mm	1933	1450	
22mm	1615	1450	
24mm	1931	1451	TJ717
28mm	1623	1450	
30mm	1933	1450	

### WA AWNING SASH

GLASS THICKNESS	CHANNEL REQUIRED
6mm	1605

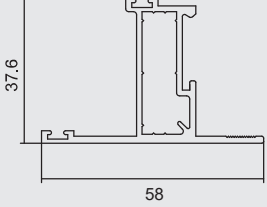

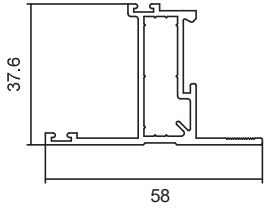
# 35MM AWNING & CASEMENT WINDOW SECTIONS

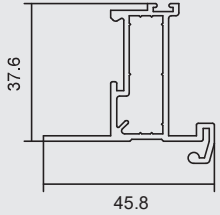
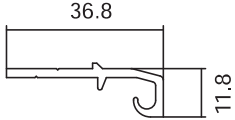
CODE	DESCRIPTION	LGTH.	FINISH	GROUP ID	
TJ723	35 Awning Sash with 58mm Flat Face Fits with TJ300/301/390/709/720/016  1851, 1601, 1854	6.5m	M/F CL/ANOD BZ/ANOD	9901 9902 9901	
TJ722	35 Awning Sash with 58mm Rebate Face Fits with TJ301/300/390/709/720/016  1851, 1601, 1854	6.5m	M/F CL/ANOD BZ/ANOD	9901 9902 9901	
TJ724	35 Hinge Awning Sash Fits with TJ016/709/725 <i>*Use only with TJ722*</i>  1851, 1601, 1854	6.5m	M/F CL/ANOD	9901 9902	
TJ725	35 Awning Sash Hinge Suits TJ722/300/301/304/390	6.5m	M/F CL/ANOD BZ/ANOD	9901 9902 9901	



 Key hardware.

# 35MM AWNING & CASEMENT WINDOW SECTIONS

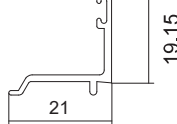
	CODE	DESCRIPTION	LGTH.	FINISH	GROUP ID
	TJ720	35 Awning Stop Fits with TJ301/300/390/304/722/723	6.5m	M/F CL/ANOD BZ/ANOD	9901 9902 9901
	TJ709	6-10mm 35 Awning Glazing Bead Fits with TJ722/723/724  1601, 1620, 1630	6.5m	M/F CL/ANOD BZ/ANOD	9401 9402 9401
	TJ713	12 -18mm 35 Awning Glazing Bead Fits with TJ722/723/724  1615, 1620, 1630	6.5m	M/F CL/ANOD	9901
	TJ016	20-24mm 35 Double Glazing Bead Fits with TJ722/723/724  1601, 1615, 1620	6.5m	M/F CL/ANOD	10301 10302

 Key hardware.





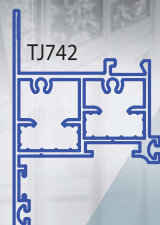
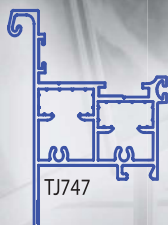







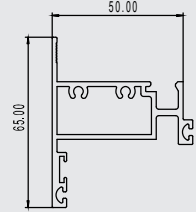

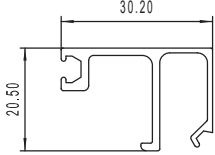
**COMING IN  
2022!**

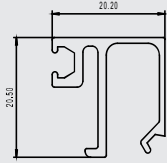
**50mm Universal  
Awning/Casement to  
accept chainwinder,  
stays, hook and  
multipoint locking.**

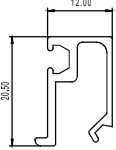
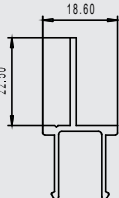

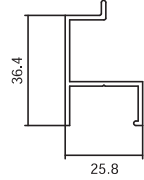
CODE	DESCRIPTION
TJ742	50mm Universal Awning/Casement Sash
TJ747	50mm Hook Universal Awning Sash
TJ748	Awning/Casement Stop - Recessed
TJ749	Awning Hook Sash Jamb Stop
CGM001	Control Bar and Stay Packer
CGM002	50mm Plant-on Awning Hook
CSG728	Built-in Hook Head/Sill/Transom - 100mm
DGF6572	Built-in Hook Head/Sill/Transom - 150mm

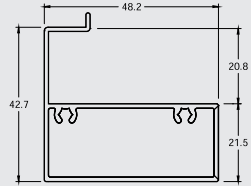
# 50MM AWNING & CASEMENT WINDOW SECTIONS

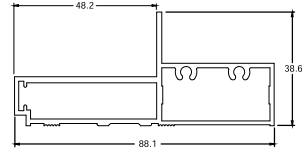





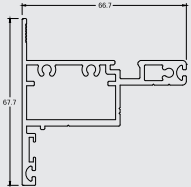

CODE	DESCRIPTION	LGTH.	FINISH	GROUP ID	
TJ741	50 Heavy Duty Awning Sash Fits with TJ714/716/717  1863, 1864, 2641, 1855 	6.5m	M/F CL/ANOD	9901	
TJ714	6-12mm 50 Awning Bead Fits with TJ741  1615, 1620, 1623, 1931	6.5m	M/F CL/ANOD	9901 9902	
TJ716	16-22mm 50 Awning Bead Fits with TJ741  1615, 1931, 1933	6.5m	M/F CL/ANOD	9901 9902	
TJ717	24-30mm 50 Awning Bead Fits with TJ741  1623, 1931, 1933	6.5m	M/F CL/ANOD	9901 9902	
TJ715	50 Awning Sash Stop Fits with TJ301/724 Suits Sash TJ741	6.5m	M/F CL/ANOD	9901 9902	
TJ737	Flyscreen Adaptor/Winder Support Fits with TJ301/720/736  1080, 1090	6.5m	M/F CL/ANOD	9901 9902	
TJ734	Chain Winder Support  1080, 1082, 1090, 1092	6.5m	M/F CL/ANOD	9901	
TJ745	HD Awning Flush Recess Stop  1863, 1864, 1855	6.5m	M/F	9901	

 Key hardware.

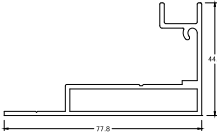
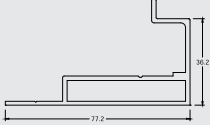
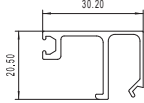

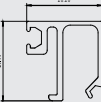

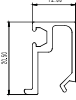
 Technical guidance recommended.

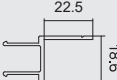
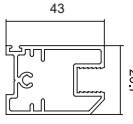

# TRUTH / AWNING WINDOW SECTIONS

	CODE	DESCRIPTION	LGTH.	FINISH	GROUP ID
	TJ770	Awning/Casement Sash Fits with TJ714/716/717  1863, 1864, 2641, 1855	6.5m	M/F	9901
	TJ771	Awning/Casement Head and Sill Adapter	6.5m	M/F	9901
	TJ772	Awning/Casement Jamb Adapter	6.5m	M/F	9901
	TJ714	6-12mm 50 Awning Bead. Fits with TJ770  1615, 1620, 1623, 1931	6.5m	M/F CL/ANOD	9901 9902
	TJ716	16-22mm 50 Awning Bead. Fits with TJ770  1615, 1931, 1933	6.5m	M/F CL/ANOD	9901 9902
	TJ717	24-30mm 50 Awning Bead. Fits with TJ770  1623, 1931, 1933	6.5m	M/F CL/ANOD	9901 9902

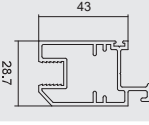
# W.A. AWNING WINDOW SECTIONS

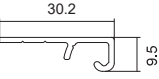
	CODE	DESCRIPTION	LGTH.	FINISH	GROUP ID
	TJ736	Sash Stop Fits with TJ301/738/739	6.5m	M/F CL/ANOD	9901 9902
	TJ738	Awning Sash. Fits with TJ739  1605	6.5m	M/F CL/ANOD	9901 9902
	TJ739	Hinge Sash  1605	6.5m	M/F CL/ANOD	9901 9902
	TJ740	Window Hinge Fits with TJ739/TJ301	6.5m	M/F CL/ANOD	9901 9902

 Key hardware.

# AWNING & CASEMENT WINDOW HARDWARE

CODE	DESCRIPTION	U.O.M.	BOX QTY.	GROUP ID	
1080**	Whitco Mk8 Non-Locking Chainwinder - Standard <i>**Specify finish: Black - BL, White - WH, Primose - PR.</i>	Each	10	16137	
1082	Whitco Mk8 Non-Locking Chainwinder - Black Non Corrosive	Each	10	16137	
1090	Whitco Mk8 Locking Chainwinder - K/N 32381 - Standard <i>**Specify finish: Black-BL, White Birch - WB, White - WH, Primose - PR, Silver - SCA.</i>	Each	10	16137	
1092	Locking Chainwinder - Black K/N 32381 - Non-corrosive	Each	NA	16137	
1098-SQ	Chain Length Restriction Plug - Works with 1080, 1082, 1090, 1092	Each	10	16137	
1099	Chainwinder Bracket - Black Height = 20mm	Each	20	16137	
1240	Awning Handle - Wedgeless Right Hand - Black Non-Locking	Each	10	16149	
1241	Awning Handle - Wedgeless Left Hand - Black Non-Locking	Each	10	16149	
1242	Awning Handle - Wedgeless Right Hand - Black Locking	Each	10	16149	
1243	Awning Handle - Wedgeless Left Hand - Black Locking	Each	10	16149	<i>Right Hand Non-Locking Shown</i>
1244	High Performance Cam Handle Lock - To Suit TJ741 - Right Hand - Black Non-Locking	Each	10	16145	
1245	High Performance Cam Handle Lock - To Suit TJ741 - Left Hand - Black Non-Locking	Each	10	16145	
1246	High Performance Cam Handle Lock - To Suit TJ741 - Right Hand - Black Locking	Each	10	16145	
1247	High Performance Cam Handle Lock - To Suit TJ741 - Left Hand - Black Locking	Each	10	16145	

 Please check with your local branch for stock availability.

# AWNING & CASEMENT WINDOW HARDWARE





	CODE	DESCRIPTION	U.O.M.	BOX QTY.	GROUP ID
	1200	Aluminium A Stay Awning 235mm - Friction - Black - 6kg Max Height = 750mm Stack Height = 13mm	Pair	30pr	16141
	1201	Aluminium A Stay Awning 235mm - Non Friction - Black - 10kg Stack Height = 13mm	Pair	30pr	16141
	1210	Stainless Steel 254mm Awning Stay Max = 450mm/14kg/84° Stack Height = 13mm	Pair	25pr	16141
	1211	Stainless Steel 402.5mm Awning Stay Max = 550mm/20kg/60° Stack Height = 13mm	Pair	25pr	16141
	1212	Stainless Steel 502.5mm Awning Stay Max = 1200mm/24kg/45° Stack Height = 13mm	Pair	25pr	16141
	1237	Stainless Steel 602mm Awning Stay Max = 1800mm/35kg Stack Height = 13mm	Pair	25pr	16141
	1220	Stainless Steel Restrictor Stay - Light Duty	Pair	25pr	16141
	1281	263mm Heavy Duty Stainless Steel Stay Awning - Weight = 50kg / Height = 762mm Casement - Weight 34.4kg / Width = 660mm Stack Height = 16mm	Pair	25pr	16141
	1282	414mm Heavy Duty Stainless Steel Stay Max Awning - Weight = 63kg / Height = 1120mm Casement - Weight 37kg / Width = 800mm Stack Height = 16mm	Pair	25pr	16141
	1283	567mm Heavy Duty Stainless Steel Stay Max Awning - Weight = 74kg / Height = 1321mm Casement - Weight 42kg / Width = 800mm Stack Height = 16mm	Pair	25pr	16141
	1213	683mm Heavy Duty Stainless Steel Stay Max Awning - Weight = 90kg / Height = 1800mm Stack Height = 16mm	Pair	25pr	16141
	1284	724mm Heavy Duty Stainless Steel Stay Awning - Weight = 130kg / Height = 2000mm Stack Height = 16mm	Pair	25pr	16141
	1285	Stainless Steel Restrictor Stay - Heavy Duty	Pair	25pr	16141

# AWNING & CASEMENT WINDOW HARDWARE





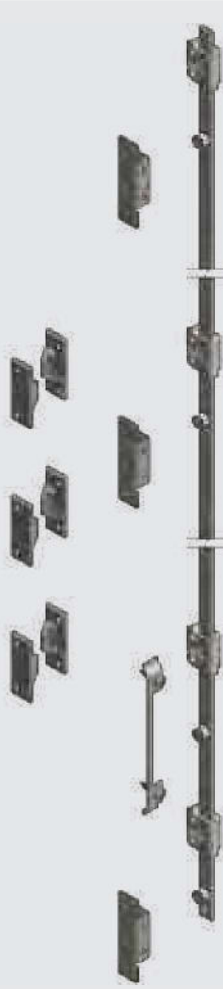





CODE	DESCRIPTION	U.O.M.	BOX QTY.	GROUP ID	
21001/ AWNKIT1SS	Awning Operator Kit #1 - Stainless Steel For Sashes 500-700mm High - 26kg MAX	Set	N/A	16137	
21001/ AWNKIT2SS	Awning Operator Kit #2 - Stainless Steel For Sashes 701-900mm High - 45kg MAX	Set	N/A	16137	
21001/ AWNKIT3SS	Awning Operator Kit #3 - Stainless Steel For Sashes 901-1050m High - 53kg MAX	Set	N/A	16137	
21001/ AWNKIT4SS	Awning Operator Kit #4 - Stainless Steel For Sashes 1051-1200mm High - 58kg MAX	Set	N/A	16137	
21001/ AWNKIT5SS	Awning Operator Kit #5 - Stainless Steel For Sashes 1201-1600mm High - 80kg	Set	N/A	16137	
21001/ AWNKIT6SS	Awning Operator Kit #6 - Stainless Steel For Sashes 1601-2100mm High - 136kg MAX	Set	N/A	16137	
21002/ CASKT1LSS	Casement Operator Kit #1 - LH SS For Sashes 450-600mm Wide L/H Open	Set	N/A	16137	
21002/ CASKT1RSS	Casement Operator Kit #1 - RH SS For Sashes 450-600mm Wide R/H Open	Set	N/A	16137	
21002/ CASKT2LSS	Casement Operator Kit #1 - LH SS For Sashes 651-1000mm Wide L/H Open	Set	N/A	16137	
21002/ CASKT2RSS	Casement Operator Kit #2 - RH SS For Sashes 651-1000mm Wide R/H Open	Set	N/A	16137	
21003/ CVHANLSIL	Tango Cover & Handle LH - Alum Encore	Set	N/A	16137	
21003/ CVHANLCLK	Tango Cover & Handle LH - Black Encore	Set	N/A	16137	
21003/ CVHANLWH	Tango Cover & Handle LH - White Encore	Set	N/A	16137	
21004/ CVHANRSIL	Tango Cover & Handle RH - Alum Encore	Set	N/A	16137	
21004/ CVHANRCLK	Tango Cover & Handle RH - Black Encore	Set	N/A	16137	
21004/ CVHANRWH	Tango Cover & Handle RH - White Encore	Set	N/A	16137	
21005/ KEYCVLSIL	Key Lock Cover & Handle LH - Alum NO Cylinder	Set	N/A	16137	
21005/ KEYCVLCLK	Key Lock Cover & Handle LH - Black NO Cylinder	Set	N/A	16137	
21005/ KEYCVLWH	Key Lock Cover & Handle LH - White NO Cylinder	Set	N/A	16137	
21006/ KEYCVRSIL	Key Lock Cover & Handle RH - Alum NO Cylinder	Set	N/A	16137	
21006/ KEYCVRCLK	Key Lock Cover & Handle RH - Black NO Cylinder	Set	N/A	16137	
21006/ KEYCVRWH	Key Lock Cover & Handle RH - White NO Cylinder	Set	N/A	16137	
21007/ WFCYL	FSA Wafer Cyl K/N:32304 wth Exchange Barrel for Encore Locking (1 per Cover)	Each	N/A	16137	

 Key hardware.

# AWNING & CASEMENT WINDOW HARDWARE





	CODE	DESCRIPTION	U.O.M.	BOX QTY.	GROUP ID
	21011/ SPKTSS	Single Point Locking Kit	Set	N/A	16137
	21011/ SPLHNSIL	Single Point Lock Handle for Awning Sashes up to 700mm High (Silver)	Set	N/A	16137
	21011/ SPLHNBLK	Single Point Lock Handle for Awning Sashes up to 700mm High (Black)	Set	N/A	16137
	21011/ SPLHNWH	Single Point Lock Handle for Awning Sashes up to 700mm High (White)	Set	N/A	16137
	21008/ MPTKT1LSS	Multipoint Lock Kit #1 LH Stainless Steel For Awning Sashes 1201-2100mm High	Set	N/A	16137
	21008/ MPTKT2LSS	Multipoint Lock Kit #2 LH Stainless Steel For Casement Sashes 1201-1500mm High	Set	N/A	16137
	21008/ MPTKT2RSS	Multipoint Lock Kit #2 RH Stainless Steel For Casement Sashes 1201-1500mm High	Set	N/A	16137
	21008/ MPTKT3LSS	Multipoint Lock Kit #3 LH Stainless Steel For Casement Sashes 1501-1600mm High	Set	N/A	16137
	21008/ MPTKT3RSS	Multipoint Lock Kit #3 RH Stainless Steel For Casement Sashes 1501-1600mm High	Set	N/A	16137
	21008/ MPTKT4LSS	Multipoint Lock Kit #4 LH Stainless Steel For Casement Sashes 1601-1700mm High	Set	N/A	16137
	21008/ MPTKT4RSS	Multipoint Lock Kit #4 RH Stainless Steel For Casement Sashes 1601-1700mm High	Set	N/A	16137
	21008/ MPTKT5LSS	Multipoint Lock Kit #5 LH Stainless Steel For Casement Sashes 1701-1800mm High	Set	N/A	16137
	21008/ MPTKT5RSS	Multipoint Lock Kit #5 RH Stainless Steel For Casement Sashes 1701-1800mm High	Set	N/A	16137
	21008/ MPTKT6LSS	Multipoint Lock Kit #6 LH Stainless Steel For Casement Sashes 1801-1900mm High	Set	N/A	16137
	21008/ MPTKT6RSS	Multipoint Lock Kit #6 RH Stainless Steel For Casement Sashes 1801-1900mm High	Set	N/A	16137
	21008/ MPTKT7LSS	Multipoint Lock Kit #7 LH Stainless Steel For Casement Sashes 1901-2350mm High	Set	N/A	16137
	21008/ MPTKT7RSS	Multipoint Lock Kit #7 RH Stainless Steel For Casement Sashes 1901-2350mm High	Set	N/A	16137
		21010/ MPTLHNSIL	Multipoint Locking Handle - Alum Maxim (with Gasket)	Set	N/A
21010/ MPTLHNBLK		Multipoint Locking Handle - Black Maxim (with Gasket)	Set	N/A	16137
21010/ MPTLHNWH		Multipoint Locking Handle - White Maxim (with Gasket)	Set	N/A	16137

# AWNING & CASEMENT WINDOW HARDWARE

CODE	DESCRIPTION	U.O.M.	BOX QTY.	GROUP ID	
1450	Glazing Tape - D/Sided Black PVC 1.6mm x 12mm - 45.7m Roll	Roll	20	16165	
1451	Glazing Tape - D/Sided Black PVC 3.2mm x 12mm - 25m Roll	Roll	20	16165	
1452	Glazing Tape - D/Sided Black PVC 4.8mm x 12mm - 15.2m Roll	Roll	20	16165	
1453	Glazing Tape - D/Sided Black PVC 6.4mm x 12mm - 15.2m Roll	Roll	20	16165	
1600	Bulb Seal PVC - 250m Roll	Roll	1	16169	
1601	Bulb Seal Co-Extruded - 100m Roll	Roll	N/A	16169	
2641	Qlon - Push in - 500m Roll Suits TJ741	Roll	N/A	16169	
1615	Glazing Wedge PVC - 200m Roll	Roll	1	16169	
1620	Glazing Wedge PVC - 200m Roll	Roll	1	16169	
1630	Glazing Wedge PVC - 200m Roll	Roll	1	16169	
1605	Glazing Channel to Suit 6mm Awning Window - 200m Roll Suits TJ738/739	Roll	N/A	16169	
1931	Glazing Wedge - 100m Roll	Roll	1	17320	
1623	Glazing Wedge - 100m Roll	Roll	1	17320	
1933	Glazing Wedge - 150m Roll	Roll	1	17320	

WA SASH ONLY

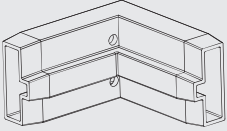
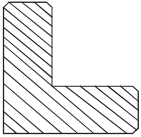
# AWNING & CASEMENT WINDOW HARDWARE

	CODE	DESCRIPTION	U.O.M.	BOX QTY.	GROUP ID
	1851	35mm Corner Stake for Awning Sash Suits TJ722/723/724/725/726/729	Each	100	16153
	1854	35mm Corner Stake for Sash Suitable for Crimping Suits TJ722/723	Each	100	16153
	1863	50mm Plastic Corner Stake for TJ741/770 (left & right handed)	Bag	20	16153
	1864	50mm Sash Corner Plate for TJ741/770	Bag	100	16153
	1855	50mm Metal Corner Stake for TJ741/770	Bag	20	16153









## MULTIFOLD DOOR SYSTEM

MULTIFOLD DOOR SYSTEM		
GLASS THICKNESS	WEDGE REQUIRED	POCKET SIZE
6mm	1620 - 1620 OR 1615 - 1625 OR 1620 - 1684	14.5mm
8mm	1625 - 1625 OR 1620 - 1630 OR 1630 - 1684	
10mm	1630 - 1630	
20mm	1623 - 1623	35.1mm
22mm	1933 - 1933	
24mm	1615 - 1623 OR 1615 - 1933	
26mm	1615 - 1615 OR 1615 - 1684	
28mm	1620 - 1620 OR 1620 - 1684	

MULTIFOLD DOOR SYSTEM DOUBLE BEADED			
GLASS THICKNESS	WEDGE REQUIRED	SPECIFIC PROFILES REQUIRED	POCKET SIZE
6mm	1630 - 1623 OR 1630 - 1933	TJ202 bead	16.75mm
8mm	1620 - 1620		
10mm	1625 - 1625 OR 1630 - 1684		
12mm	1630 - 1630		
20mm	1623 - 1623	TJ227 bead	35.1mm
22mm	1615 - 1623		
24mm	1620 - 1933 OR 1933 - 1684		
26mm	1630 - 1623 OR 1623 - 1684		



1615



1620



1623



1625



1630







1933



1684

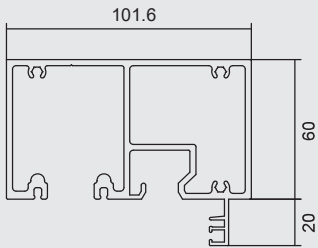

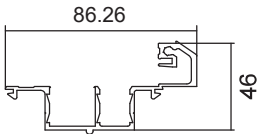
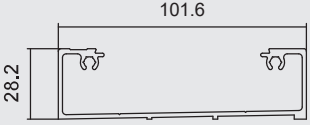

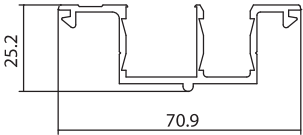
# STANDARD FLUSHBOLT MULTIFOLD DOOR

CODE	DESCRIPTION	LGTH	FINISH	GROUP ID	
HV039	60mm Head  1066, 1681	6.5m	M/F CL/ANOD	10501 10502	
HV034	Reversible Sill Insert Fits with HV035 & HV057  1066, 1681, 1680-H	6.5m	M/F CL/ANOD	10501 10502	
HV035	Sill Base Slotted Fits with HV034/037	6.5m	M/F CL/ANOD	10501 10502	
HV037	Flat Reversible Sill Fits with HV035 & HV057  1680-H	6.5m	M/F CL/ANOD	10501 10502	



 Key hardware.

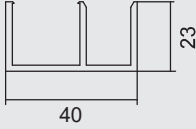
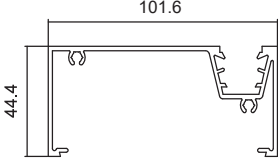

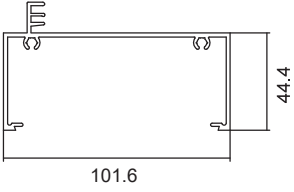
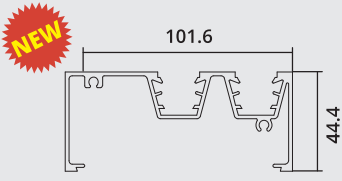
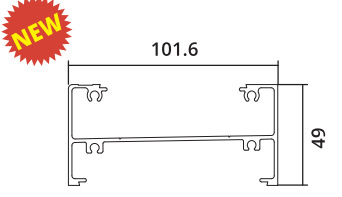
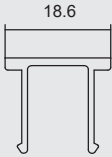



# STANDARD FLUSHBOLT MULTIFOLD DOOR

	CODE	DESCRIPTION	LGTH.	FINISH	GROUP ID
	HV036	In-Ground Channel Key hardware: 1066, 1680-H	6.5m	M/F CL/ANOD	10501 10502
	HV030	Snap In Jamb Fits with HV031	6.5m	M/F CL/ANOD	10501 10502
	HV031	Snap In Door Stop Fits with HV030 & HV056 Key hardware: 1681	6.5m	M/F CL/ANOD	10501 10502
	HV005-N	Jamb Key hardware: 1681	2.8m	M/F CL/ANOD	10501 10502
	HV056	Bifold Continuous Jamb Fits with HV031 & TJ307	6.5m	M/F CL/ANOD	10501
	HV057	Bifold Transom for Continuous Jamb Fits with HV034 & HV037	6.5m	M/F CL/ANOD	10501
	TJ307	Flush Pocket Filler Fits with HV056	6.5m	M/F CL/ANOD BZ/ANOD	8301 8302 8301

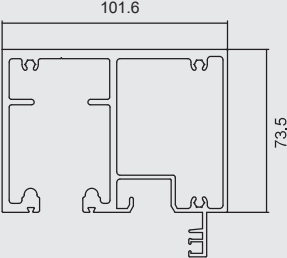
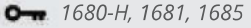
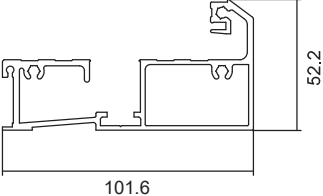
 Key hardware.

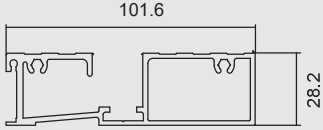
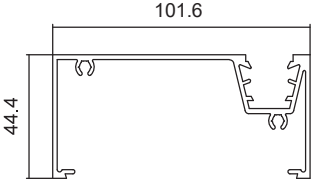
HarbourView™ • Multifold Door System

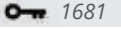
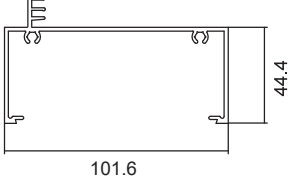
# BRIO FLUSHBOLT MULTIFOLD DOOR

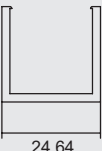
CODE	DESCRIPTION	LGTH.	FINISH	GROUP ID	
HV009	One Piece Head Track  1681	6.5m	M/F CL/ANOD	10501 10502	
HV004	Sill (Slotted)  1680-H, 1681, 1685	6.5m	M/F CL/ANOD	10501 10502	
HV006	Flat Sill (Slotted)  1680-H, 1685	6.5m	M/F CL/ANOD	10501 10502	
HV030	Snap In Jamb Fits with HV031	6.5m	M/F CL/ANOD	10501 10502	
HV031	Snap In Door Stop Fits with HV030 & HV056  1681	6.5m	M/F CL/ANOD	10501 10502	
HV005-N	Jamb  1681	2.8m	M/F CL/ANOD	10501 10502	
		6.5m	M/F CL/ANOD	10501 10502	
HV010	In-Ground Channel  1680-H	6.5m	M/F CL/ANOD	10501 10502	

 Key hardware.



# BRIO BOTTOM ROLLING MULTIFOLD DOOR

	CODE	DESCRIPTION	LGTH.	FINISH	GROUP ID
	HV401	HarbourView Bottom Rolling Head Key 1681	6.5m	M/F CL/ANOD	10501 10502
	HV402	HarbourView Bottom Rolling Sill Key 1683, 1685, 1699, 1699-Grub	6.5m	M/F CL/ANOD	10501 10502
	HV403	HarbourView Bottom Rolling Inward Sill Key 1683, 1685, 1699, 1699-Grub	6.5m	M/F CL/ANOD	10501
	HV404	HarbourView Bottom Rolling Outward Flush Sill Key 1683, 1685, 1699, 1699-Grub	6.5m	M/F CL/ANOD	10501
	HV405	HarbourView Bottom Rolling Inward Flush Sill Key 1683, 1685, 1699, 1699-Grub	6.5m	M/F CL/ANOD	10501
	HV030	Snap In Jamb Fits with HV031	6.5m	M/F CL/ANOD	10501 10502
	HV031	Snap In Door Stop Fits with HV030 & HV056 Key 1681	6.5m	M/F CL/ANOD	10501 10502
	HV056	Bifold Continuous Jamb Fits with HV031 & TJ307	6.5m	M/F CL/ANOD	10501
	TJ307	Flush Pocket Filler Fits with HV056	6.5m	M/F CL/ANOD BZ/ANOD	8301 8302 8301

Key hardware.









HarbourView™ • Multifold Door System

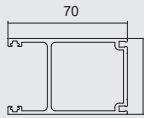



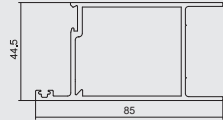

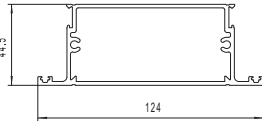

# SINGLE GLAZED MULTIFOLD DOOR

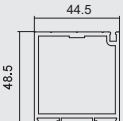
CODE	DESCRIPTION	LGTH.	FINISH	GROUP ID	
HV271	Door Stile Fits with HV273/289  1682, 1825, 1829	2.8m	M/F CL/ANOD	10501 10502	
		6.5m	M/F CL/ANOD	10501 10502	
HV281	Heavy Duty Door Stile Fits with HV273/289  1682, 1825, 1829	6.5m	M/F CL/ANOD	10501 10502	
HV289	Small Rail Fits with HV271/272/274/281  1825	6.5m	M/F CL/ANOD	10501 10502	
HV273	Large Rail Fits with HV271/272/274/281  1825	6.5m	M/F CL/ANOD	10501 10502	
HV274	Door Bead Fits with HV273/289	6.5m	M/F CL/ANOD	10501 10502	

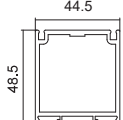
 Key hardware.

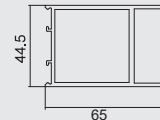
# DOUBLE GLAZED MULTIFOLD DOOR

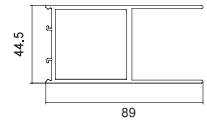
	CODE	DESCRIPTION	LGTH.	FINISH	GROUP ID
	HV291	Double Glazed Multifold Stile Fits with HV275/277  1826, 1682	6.5m	M/F CL/ANOD	10501 10502
	HV275	Double Glazed Multifold Large Rail Fits with HV276/291  1826	6.5m	M/F CL/ANOD	10501 10502
	HV277	HV Small Double Glazed Rail Fits with HV276/291  1826	6.5m	M/F CL/ANOD	10501 10502
	HV278	124mm Double Glazed Mid Rail Fits with HV276/291	6.5m	M/F CL/ANOD	10501 10502
	HV276	Double Glazed Multifold Bead Fits with HV275/277/278	6.5m	M/F CL/ANOD	10501 10502

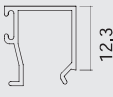
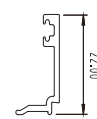
	CODE	DESCRIPTION	LGTH.	FINISH	GROUP ID
	TJ220	Multifold Door Stile Fits with TJ202/227  1820, 2590, 2600, 2610, 2620	6.5m	M/F CL/ANOD	9501 9502
	TJ211	Multifold Door Stile Fits with TJ203/207/227  1682, 1820	6.5m	M/F CL/ANOD	9501 9502
	TJ207	Small Rail Fits with TJ211/227  1820	6.5m	M/F CL/ANOD	9501 9502
	TJ203	Large Rail Fits with TJ211/227  1820	6.5m	M/F CL/ANOD	9501 9502
	TJ202	Door Bead Fits with TJ200/201/204/210/211/226	6.5m	M/F CL/ANOD	9501 9502
	TJ227	Double Glazed Bead Fits with TJ211/207/203	6.5m	M/F CL/ANOD	9501 9502

 Key hardware.

HarbourView™ • Multifold Door System

# TOP ROLLING MULTIFOLD DOOR HARDWARE

CODE	DESCRIPTION	U.O.M.	BOX QTY.	GROUP ID	
15300	Straight Hinge Set with Handle - Outward	Set	1	16101	
15500	Straight Hinge Set - Inward	Set	1	16101	
15600	Offset Hinge Set - Inward	Set	1	16101	
15700	Offset Hinge Set with Handle - Outward	Set	1	16101	
15100	Pivot Set 100kg - SS	Set	1	16101	
15250	End Hanger Set 50kg - SS	Set	1	16101	
15275	End Hanger Set 100kg - SS	Set	1	16101	
15475	Intermediate Hanger Set 100kg - SS	Set	1	16101	
15445	Intermediate Hanger Set 50kg - SS	Set	1	16101	





# BOTTOM ROLLING MULTIFOLD DOOR HARDWARE

	CODE	DESCRIPTION	U.O.M.	BOX QTY.	GROUP ID
	15300	Straight Hinge Set with Handle - Outward	Set	1	16101
	15500	Straight Hinge Set - Inward	Set	1	16101
	15600	Offset Hinge Set - Inward	Set	1	16101
	15700	Offset Hinge Set with Handle - Outward	Set	1	16101
	15800	Bottom Rolling Pivot Set - 80kg	Set	1	16101
	15801	Bottom Rolling End Guide Set - Left Hand - 80kg <i>Outward - Stacking to left</i> <i>Inward - Stacking to right</i>	Set	1	16101
	15802	Bottom Rolling End Guide Set - Right Hand - 80kg <i>Outward - Stacking to right</i> <i>Inward - Stacking to left</i>	Set	1	16101
	15803	Bottom Rolling Intermediate Guide Set - 80kg	Set	1	16101
	1699	6mm 304 SS Rod, 6 metre	Each	N/A	16101
	1699-Grub	Grub Screw 1/4" X 1/2" UNC CUP PNT	Each	N/A	16101

HarbourView™ • Multifold Door System

# MULTIFOLD DOOR HARDWARE

CODE	DESCRIPTION	U.O.M.	BOX QTY.	GROUP ID	
1820	Spigots for Double Beaded Door Set of 4 Includes Bolts Suits TJ211/203/207	Set	1	16153	
1825	Spigots for Multifold Door Set of 4 includes Bolts Suits HV271/272/273/281/289	Set	1	16101	
1829	Spigot Saddle Fits with 1825 - Optional	Each	1	16153	
1826	Spigots to Suit Multifold Door Set of 4 with Bolts Suits HV291/275/277	Set	1	16101	
15401	Flush Pull-SS	Each	1	16101	
15124	BRIO Multifold Flushbolt Non-Locking 400mm-SS	Each	1	16101	
15126	BRIO Multifold Flushbolt Non-Locking 600mm-SS	Each	1	16101	
15129	BRIO Multifold Flushbolt Non-Locking 900mm-SS	Each	1	16101	
15124L	BRIO Multifold Flushbolt Locking 400mm-SS	Each	1	16101	
15126L	BRIO Multifold Flushbolt Locking 600mm-SS	Each	1	16101	
15129L	BRIO Multifold Flushbolt Locking 900mm-SS	Each	1	16101	
15130	BRIO Flushbolt Surround SSS To Suit 512 Flushbolt (15124 to 15129)	Each	1	16101	

# MULTIFOLD DOOR HARDWARE

	CODE	DESCRIPTION	U.O.M.	BOX QTY.	GROUP ID
	1066-**	Flushbolt Standard - 300mm <i>**Specify finish: Black-BL, Satin Chrome-SC.</i>	Each	10	16121
	1066-ROD600	Flushbolt Extension Rod Only 600mm Suits 1066	Each	1	16201
	1066-ROD900	Flushbolt Extension Rod Only 900mm Suits 1066	Each	1	16201
	1068	Floor Ferule to Suit 1066/1067 Flushbolt Stainless Steel	Each	1	16121
	1055-FBB	Flushbolt Block Suits HV271 with Standard Flushbolt	Each	N/A	16101
	15141	Brio 286 Dual Point Lock Body	Each	1	16101
	15142-SSS	Brio 286 Dual Point Non-Locking Handle Satin Stainless Steel	Each	1	16101
	15142-Z-BL	Brio 286 Dual Point Non-Locking Handle Zinc - Black Powdercoated	Each	1	16101
	15143-SSS	Brio 286 Dual Point Locking Handle Satin Stainless Steel	Each	1	16101
	15143-Z-BL	Brio 286 Dual Point Locking Handle Zinc - Black Powdercoated	Each	1	16101
	15142-SSS-SK	Brio 286 Dual Point Kit 2.5m, Non-Locking - Satin Stainless Steel	Each	1	16101
	15142-ZBL-SK	Brio 286 Dual Point Kit 2.5m, Non-Locking, Zinc - Black PC	Each	1	16101
	15142-ZSN-SK	Brio 286 Dual Point Kit 2.5m, Non-Locking, Zinc - Satin Nickel	Each	1	16101
	15142-SN-SK35	Brio 286 Dual Point Kit 3.5m, Non-Locking - Satin Nickel	Each	1	16101
	15142-SSS-SK35	Brio 286 Dual Point Kit 3.5m, Non-Locking - Satin Stainless Steel	Each	1	16101
	15143-SSS-SK	Brio 286 Dual Point Kit 2.5m, Locking - Satin Stainless Steel	Each	1	16101
	15143-ZBL-SK	Brio 286 Dual Point Kit 2.5m, Locking, Zinc - Black PC	Each	1	16101
	15143-ZSN-SK	Brio 286 Dual Point Kit 2.5m, Locking, Zinc - Satin Nickel	Each	1	16101
	15143-SN-SK	Brio 286 Dual Point Kit 2.5m, Locking - Satin Nickel	Each	1	16101

 Please check with your local branch for stock availability.

HarbourView™ • Multifold Door System

# MULTIFOLD DOOR HARDWARE

CODE	DESCRIPTION	U.O.M.	BOX QTY.	GROUP ID	
15131	Twin Point Multifold Lock No Cylinder - Black	Set	10	16101	
15132	Twin Point Multifold Lock No Cylinder - Satin Chrome	Set	10	16101	
15133	Twin Point Multifold Lock with Cylinder Black	Set	10	16101	
15134	Twin Point Multifold Lock with Cylinder Satin Chrome	Set	10	16101	
15137	Extension Rod (2700mm High Doors) Suits 15131/15132	Set	10	16101	
15138	Rod Joiner Fits with 15137	Set	10	16101	
15144A	Brio 286 Dual Point Rod Pack - 1.3m to 2.5m	Each	N/A	16101	
15144B	Brio 286 Dual Point Rod Pack - 2.5m to 3.5m	Each	N/A	16101	
1141	Optimum 2 Point Lock Body Only - 30mm Backset (Cylinder Not Included)	Each	10	16129	
1147	Palladium Handle - Black Suits 1141 Lock	Set	10	16129	
1148	Palladium Handle - Satin Pearl Suits 1141 Lock	Set	10	16129	
1142	Palladium "Xtra" Handle Entrance Set - Black To Fit with 1141	Each	10	16129	
1143	Palladium "Xtra" Handle Entrance Set - Satin Chrome to Fit with 1141	Each	10	16129	
1153	Optimum / Palladium Kits - Black (1141 Lock & Striker, 1147) No Cylinder	Set	10	16129	
1154	Optimum / Palladium Kits - Satin Chrome (1141 Lock & Striker, 1148) No Cylinder	Set	10	16129	

# MULTIFOLD DOOR HARDWARE



## ALLEGION SCHLAGE RANGE

	CODE	DESCRIPTION	U.O.M.	BOX QTY.	GROUP ID
 	1172	2P Lock Body 30mm Backset with Strike Plate Suits 1145-1149 Cylinders	Each	N/A	16129
 	1174	4P Lock Body 30mm Backset with Strike Plate Suits 1145-1149 Cylinders	Each	N/A	16129
 	1174-ROD	4P Lock Rod Set 3.5m D-Tip	Each	N/A	16129



## ALLEGION VERTA RANGE

	CODE	DESCRIPTION	U.O.M.	BOX QTY.	GROUP ID
 	1011-INT	Verta Furniture Plate - Internal <i>**Specify finish: Black-BL, Stainless Steel-SS.</i>	Each	N/A	16129
 	1011-EXT	Verta Furniture Plate - External <i>**Specify finish: Black-BL, Stainless Steel-SS.</i>	Each	N/A	16129



## Verta 316 Stainless Steel Door Furniture

Influenced by classic designs, modern trends and architectural spaces – the Verta Series range of door hardware from Allegion, is made from solid stainless steel.

Every element of Verta has been sourced, crafted and finished by experts. The Verta range consists of pull handles, long-plate levers, eschuteons, bi-fold levers and other accessories that can enhance your home inside and out.

Engineered to meet Australian climatic conditions, the Verta range has been tested to endurance standards of 200,000 cycles. It also comes with a 25 year finish warranty and a 10 year mechanical warranty. Verta's precision engineering, uncompromised design and superior construction is the perfect balance between functionality and beautiful design.



# MULTIFOLD DOOR HARDWARE

## Brio BRIO 288 DUAL POINT LOCK RANGE

**CODE DESCRIPTION U.O.M. BOX QTY. GROUP ID**

15146-ZBL	Furniture Handle 85 Ctr, Zinc Black (PBK)	Each	N/A	16101	
15146-SN	Furniture Handle 85 Ctr, Satin Nickel (PVD CLR)	Each	N/A	16101	
15146-SSS	Furniture Handle 85 Ctr, Satin Stainless Steel	Each	N/A	16101	
15146-M -ZBL	Magnetic Furniture Handle 85 Ctr, Zinc Black (PBK)	Each	N/A	16101	
15146-M -SN	Magnetic Furniture Handle 85 Ctr, Satin Nickel (PVD)	Each	N/A	16101	
15146-BL -MAG	Magnetic/Rubb Leaf Catch Set, Black	Each	N/A	16101	
15146-SN -MAG	Magnetic/Rubb Leaf Catch Set, Satin Nickel	Each	N/A	16101	







**NEW**

**NEW**

**NEW**

HarbourView™ • Multifold Door System

# MULTIFOLD DOOR HARDWARE

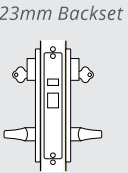
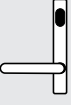
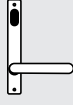
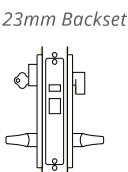
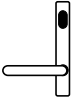
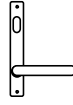
	CODE	DESCRIPTION	U.O.M.	BOX QTY.	GROUP ID
	1144	Euro Cylinder - 5 Pin/70mm. Keyed Alike Suits 1113/14/41/53/54/72/74	Each	10	16129
	1145	Euro Cylinder - 5 Pin/60mm. Keyed To Differ Suits 1113/14/41/53/54/72/74	Each	10	16129
	1146	Economy Euro Cylinder - 5 Pin/60mm Keyed Alike Suits 1113/14/41/53/54/72/74	Each	10	16129
	1149	Euro Cylinder - 5 Pin/Turn. Keyed Alike Suits 1113/14/41/53/54/72/74	Each	10	16129
	1137	S/Steel Strike - Standard Suits 1141 - Optimum Lock	Each	1	16129
	1138	S/Steel Extended Multifold Strike Suits 1141 Lock	Each	1	16101
	1176	<p>Lockwood Selector 3782 Lock Kit 01 Double Cylinder Set</p> <p><i>Includes:</i></p> <ul style="list-style-type: none"> <li>• 3782SS Mortice Lock</li> <li>• 4801/70SC Lever on External Plate with Cylinder Hole</li> <li>• 4901/70SC Lever on Internal Plate with Cylinder Hole</li> <li>• Double Cylinder</li> <li>• Accessory Packets to Suit</li> </ul>	Set	10	16129
<p>23mm Backset</p>   <p>Outside Cylinder + Lever 4801/70</p> <p>Inside Cylinder + Lever 4901/70</p>					
	1177	<p>Lockwood Selector 3782 Lock Kit 04 Cylinder and Turn Set</p> <p><i>Includes:</i></p> <ul style="list-style-type: none"> <li>• 3782SS Mortice Lock</li> <li>• 4801/70SC Lever on External Plate with Cylinder Hole</li> <li>• 4904/70SC Lever on Internal Plate with Turnknob</li> <li>• Cylinder</li> <li>• Turnknob Adaptor</li> <li>• Accessory Packets to Suit</li> </ul>	Set	10	16129
<p>23mm Backset</p>   <p>Outside Cylinder + Lever 4801/70</p> <p>Inside Turn Snib + Lever 4904/70</p>					

HarbourView™ • Multifold Door System

# MULTIFOLD DOOR HARDWARE

CODE	DESCRIPTION	U.O.M.	BOX QTY.	GROUP ID	
1178	Lockwood Selector 3782 Lock Kit 05 Single Cylinder Set  <i>Includes:</i> <ul style="list-style-type: none"> <li>• 3782SS Mortice Lock</li> <li>• 4801/70SC Lever on External Plate with Cylinder Hole</li> <li>• 4905/70SC Lever on Internal Plain Plate</li> <li>• Cylinder</li> <li>• Accessory Packets to Suit</li> </ul>	Set	10	16129	 <p>23mm Backset</p> <p>Outside Cylinder 4801/70</p> <p>Inside Lever Only 4905/70</p>
1175	Lockwood Selector 3782SS Short Backset Mortice Lock No Cylinder Included	Each	10	16129	 <p>23mm Backset</p>

## ALLEGION ALLEGION LEGGE LOCK KITS & CYLINDERS

CODE	DESCRIPTION	U.O.M.	BOX QTY.	GROUP ID	
9950S	995 V Series Vestibule Lock Office/Classroom Lock Kit Stainless Steel Single Cylinder	Each	Set	16129	 <p>23mm Backset</p> <p>NEW</p>
9951S	995 C Series Combination Entry Lock Kit Stainless Steel Cylinder & Turn Set	Each	Set	16129	
9952S	995 C Series Combination Lock Glass Door Lock Kit Stainless Steel Double Cylinder	Each	Set	16129	 <p>23mm Backset</p> <p>NEW</p>
9953B	995 V Series Vestibule Lock Office/Classroom Lock Kit Black Single Cylinder	Each	Set	16129	
9954B	995 C Series Combination Entry Lock Kit Black Cylinder & Turn Set	Each	Set	16129	
9955B	995 C Series Combination Lock Glass Door Lock Kit Black Double Cylinder	Each	Set	16129	

## dormakaba DORMAKABA MORTICE LOCKS, KITS & CYLINDERS

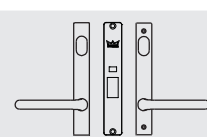
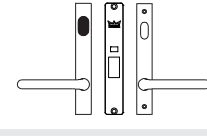
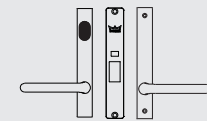
CODE	DESCRIPTION	U.O.M.	BOX QTY.	GROUP ID	
1191	Dormakaba SB2212 Lock Kit, Double Cylinder Entry Lock with 6400/6401/30 23mm Backset	Each	N/A	16129	
1192	Dormakaba SB2212 Office Lock Kit, Cylinder and Turn with 6400/6403/30 23mm Backset	Each	N/A	16129	
1193	Dormakaba SB2212 Classroom Lock Kit, External Cylinder with 6400/6406/30 23mm Backset	Each	N/A	16129	



# MULTIFOLD DOOR HARDWARE

	CODE	DESCRIPTION	U.O.M.	BOX QTY.	GROUP ID
	1101	Lockwood 4905/70 Internal Plate & Lever No Cylinder Hole - SCP	Each	10	16129
	1102	Lockwood 4901/70 Internal Plate & Lever with Cylinder Hole - SCP	Each	10	16129
	1103	Lockwood 4904/70 Internal Plate & Lever with Turn - SCP	Each	10	16129
	1103-ADP	Snib Adaptor Suits 1103 Furniture	Each	10	16133
	1104	Lockwood 4800 External Plate with Cylinder Hole - SCP	Each	10	16129
	1105	Lockwood 4801/70 External Plate & Lever with Cylinder Hole - SCP	Each	10	16129





Harbour View™ • Multifold Door System

# MULTIFOLD DOOR HARDWARE

**CODE DESCRIPTION U.O.M. BOX QTY. GROUP ID**

1120	Cylinder Single to Suit 3582 Z - Cam** - Key to Differ	Each	20	16133	 <p>"Z" Cam</p>
1121	Cylinder Single to Suit 3582 Z - Cam** - Key Alike <i>**Primary Function Outside 1105 / 1102 Inside</i>	Each	20	16133	
1122	Cylinder Single to Suit 3582 W - Cam** - Key to Differ	Each	20	16133	 <p>"W" Cam</p>
1123	Cylinder Single to Suit 3582 W - Cam** - Key Alike <i>**Cylinder &amp; Turn Function Outside 1105 / 1103 Inside</i>	Each	20	16133	
1124	Cylinder Single to Suit 3582 X - Cam** - Key to Differ	Each	20	16133	 <p>"X" Cam</p>
1125	Cylinder Single to Suit 3582 X - Cam** - Key Alike <i>**Escape Function Outside 1105 / 1101 Inside</i>	Each	20	16133	

# MULTIFOLD DOOR HARDWARE

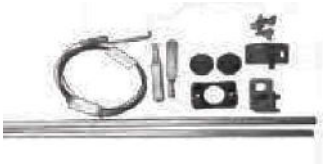





	CODE	DESCRIPTION	U.O.M.	BOX QTY.	GROUP ID
	1140	Electric Strike 12 Volt	Each	N/A	16129
	1109	Multifold Extended Strike Suit Selector Lock & Sorrento	Each	10	16129
	1155	Sorrento Face Mount Single Point Lock <i>(Cylinder not included)</i>	Each	N/A	16129
	1159	Mortice Lock Flush Mounting Tabs Suits Sorrento 1155	Pair	N/A	16129
	1157	Lazy Cam Cylinder 60mm Suits Sorrento 1155	Each	N/A	16129
	1156	Multi Point Accessory Pack Suits Sorrento 1155	Each	N/A	16129

HarbourView™ • Multifold Door System

# MULTIFOLD DOOR HARDWARE

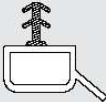
CODE	DESCRIPTION	U.O.M.	BOX QTY.	GROUP ID	
1480	Foam Seals 470 Pairs Roll Suits HV009/001	Roll	N/A	16101	
1481	Foam Seals 590 Pairs Roll Suits HV004/006	Roll	N/A	16101	
1482A	Foam Seals 1105 Pieces Roll Suits HV273/289	Roll	N/A	16101	
1615	Glazing Wedge - 200m Roll	Roll	N/A	16169	
1620	Glazing Wedge PVC - 200m Roll	Roll	N/A	16169	
1625	Glazing Wedge PVC for 8.36mm Glass - 250m Roll	Roll	N/A	16169	
1630	Glazing Wedge PVC for 10.38mm Glass - 200m Roll	Roll	N/A	16169	
1623	Glazing Wedge - 100m Roll	Roll	1	14510	
1933	Glazing Wedge - 125m Roll	Roll	N/A	16169	
1684	Glazing Wedge Co-Extruded - 150m Roll	Roll	N/A	16169	
1651	6mm Captive Wedge for 76mm Framing - 100m Roll	Roll	N/A	16169	

# MULTIFOLD DOOR HARDWARE

	CODE	DESCRIPTION	U.O.M.	BOX QTY.	GROUP ID
	1680-H	Sill Insert PVC 6.5m Black Pre-Punched Suits HV004/006/010 /034 /036	Lgth.	N/A	16101
	1681	Multifold Seal 100m Roll Suits Head / Jamb / Sill	Roll	N/A	16101
	1682	Multifold Seal - 100m Roll Suits Door Stiles	Roll	N/A	16101
	1683	Multifold Seal 100m Roll Suits High Performance	Roll	N/A	16101
	1685	Sill Flap / Insert - 300m Roll	Roll	N/A	16169
	2590	Fringe Pile 11mm x 600m Roll Black	Roll	5	6146



HarbourView™ • Multifold Door System

# MULTIFOLD DOOR HARDWARE

CODE	DESCRIPTION	U.O.M.	BOX QTY.	GROUP ID
1900-M	Frame Packers - 1.5mm X 90mm Blue 100/Bag	Bag	N/A	16157
1901-M	Frame Packers - 3mm X 90mm Green 100/Bag	Bag	N/A	16157
1902-M	Frame Packers - 5mm X 90mm Ochre 100/Bag	Bag	N/A	16157
1903-M	Frame Packers - 10mm X 90mm Black 100/Bag	Bag	N/A	16157
1906	Aluminium Frame Packers 1mm 100/Bag	Bag	N/A	6149
1907	Aluminium Frame Packers 2mm 100/Bag	Bag	N/A	6149
1908	Aluminium Frame Packers 5mm 100/Bag	Bag	N/A	6149
1909	Aluminium Frame Packers 10mm 100/Bag	Bag	N/A	6149
1910	Setting Blocks 3mm Thick - Bag of 1,000	Bag	N/A	16157
1911	Setting Blocks 5mm Thick - Bag of 1,000	Bag	N/A	16157
1912	Setting Blocks 10mm Thick - Bag of 500	Bag	N/A	16157
1977	Setting Blocks 5mm X 25mm - 3m Self Adhesive - Bag of 200	Bag	N/A	17320
1978	Setting Blocks 10mm X 25mm - 3m Self Adhesive - Bag of 200	Bag	N/A	17320
1979	Setting Blocks 3mm X 10mm X 25mm - 3m Double Sided Tape - Bag of 200	Bag	N/A	17320
1930	End Cap To Suit Subsills Bag of 50 Pairs ( <i>Left &amp; Right</i> )	Bag	N/A	16157
1960	Lanotec General Purpose Liquid Lanolin 400g	Tube	12	16181
1961	Lanotec "Citra Force" Cleaner Degreaser 400g	Tube	12	16181

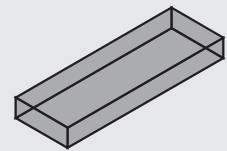

 Please check with your local branch for stock availability.

# SYSTEM TOOLING

**CODE      DESCRIPTION**



DTL3109      45mm Door Press  
-AIR      Suits TJ154/155/158/159/321/322/327/311/312/313/315  
HV271/273/281/289



DTL3123      Drill Jigs Bi-fold



Harbour View™ • Multifold Door System

# SPECIAL FEATURE



## DARLEY VICTORIA NOW OFFERING TIMBER REVEALS

Your one-stop-shop for all your aluminium window & door needs



We are pleased to announce that you can now order timber reveals cut to size with your KlassicView kits.

Darley's NEW timber reveals are:

- 138mm wide primed ALBASA timber
- Available cut to size to suit your kit order or in 5.8m lengths
- Made using a finger jointed laminating process
- Adhere to Australian standards with regards to shrinkage, moisture and warping of timber
- Responsibly sourced from timber plantations
- The new *Inline Reveal Adaptor* is also available to compliment the KlassicView line

**TO ORDER your timber reveals go to:** [www.darleyaluminium.com.au/Products/Order-Online](http://www.darleyaluminium.com.au/Products/Order-Online)













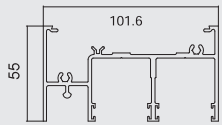

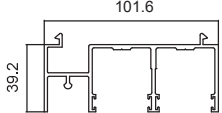

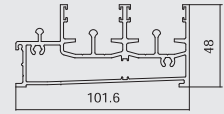

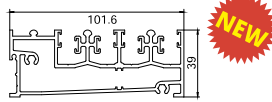
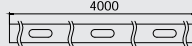
PATIO DOOR SYSTEM

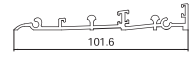
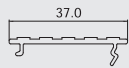
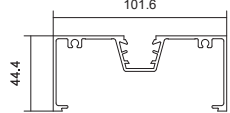
PATIO DOOR (INCLUDING SINGLE PIECE INTERLOCK)		
GLASS THICKNESS	CHANNEL RUBBER REQUIRED	POCKET SIZE
6mm	1670	12.5mm
8mm	1604	
10mm	1671	
12mm	1666	21.5mm
16mm	1689	
18mm	1667	
20mm	1677	
20.4mm	1661	

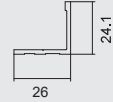
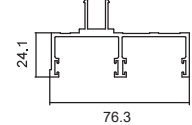
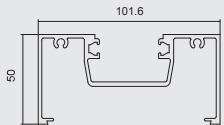

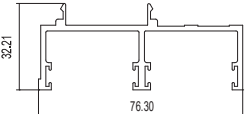
# 101.6MM PATIO DOOR

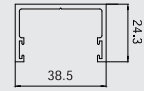
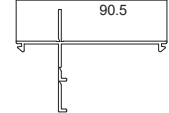
CODE	DESCRIPTION	LGTH.	FINISH	GROUP ID	
SWD411	Patio Sliding Door Head Fits with SWD416  1488, 1721	6.5m	M/F CL/ANOD	10801 10802	
SWD412	Patio Sliding Door Snap In Head Fits with TJ302  1721	6.5m	M/F CL/ANOD	10801 10802	
SWD413	Patio Sliding Door Closed Sill - Slotted  1489, 1685, 1721, FB1225-H	6.5m	M/F CL/ANOD	10801 10802	
SWD420	Patio Door Flush Sliding Sill  Fits with SWD220/320  1685, 1721, 1922, FB1225-H	6.5m	M/F CL/ANOD	10801	
FB1225-H	Sill Support with Drainage Holes. Fits with SWD413/420	4.0m	M/F CL/ANOD	10802	
SWD417	Low Profile Sill. No Water Rating  1721	6.5m	M/F CL/ANOD	10802	
SWD418	Low Profile Threshold Cap Fits with SWD417	6.5m	M/F CL/ANOD	10802	
TJ301	Standard Main Frame Fits with TJ304/305/306/TJ307/342/ SWD414/SW017/018	6.5m	M/F CL/ANOD	8301 8302	
SWD414	Patio Sliding Door Receiver. Fits with TJ301  1721	5.4m	M/F CL/ANOD	10801 10802	
SWD415	Patio Sliding Door Flyscreen Receiver Fits with SWD414	5.4m	M/F CL/ANOD	10801 10802	
CDG4301	Frame Fits with CDG4304/4307/CDG4308/4316/ DGF4506	6.5m	M/F CL/ANOD	8401 8402	
SWD036	Patio Door Receiver Channel To Suit 101.6mm CDG  1721	5.4m 5.4m	M/F CL/ANOD	10801 10802	
SWD035	Plant On Receiver Channel  1721	6.5m	M/F CL/ANOD	10801	
SWD416	Patio Door Reveal Adaptor Fits with SWD411/TJ301/SWD610/SWD611	6.5m	M/F CL/ANOD	10801 10802	

 Key hardware.









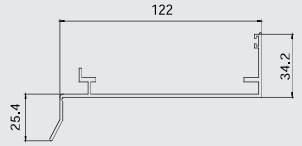

 Wheelchair access friendly

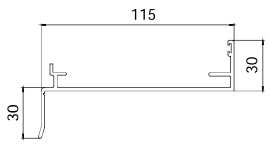
# 101.6MM PATIO DOOR

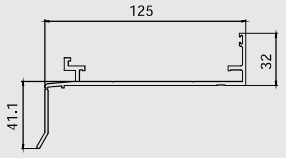
	CODE	DESCRIPTION	LGTH.	FINISH	GROUP ID
	TJ302	Sill Transom Fits with TJ303/304/305	6.5m	M/F CL/ANOD BZ/ANOD	8301 8302 8301
	TJ303	Sill Bead Fits with TJ302	6.5m	M/F CL/ANOD BZ/ANOD	8301 8302 8301
	TJ304	Glazing Adaptor Fits with TJ301/302/306/307/ TJ308/335/6151/6152	6.5m	M/F CL/ANOD BZ/ANOD	8301 8302 8301
	TJ309	49mm Sub Head 1601, 1710	6.5m	M/F CL/ANOD BZ/ANOD	10001 10002 10001
	TJ399	Heavy Duty Sub Head 1601, 1710	6.5m	M/F CL/ANOD	10001 10002
 	TJ692	80mm Sub Head 1601, 1710	6.5m	M/F CL/ANOD	10001 10002
 	TJ520	120mm Sub Head 1601, 1710	6.5m	M/F	10001 10002
	TJ430	Two Part Sub Head Fits with TJ429 1601	6.5m	M/F CL/ANOD	10001 10002
	TJ429	Sub Head Cover Fits with TJ430 1601	6.5m	M/F CL/ANOD	10001 10002
	TJ431	Standard Two Part Subhead / Jamb Fits with TJ6159 1601	6.5m	M/F CL/ANOD	10001 10002
	TJ6159	Sub Head / Jamb Cover Fits with TJ431 1601	6.5m	M/F CL/ANOD	10001 10002

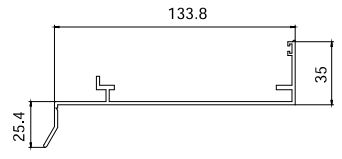
Key hardware.

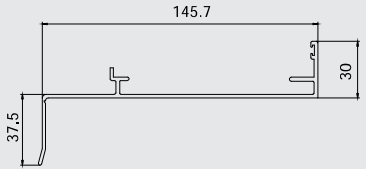
# 101.6MM PATIO DOOR

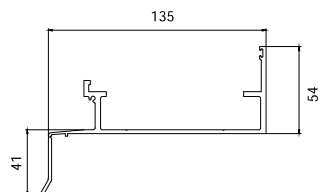
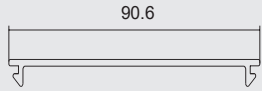
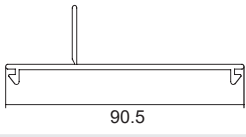
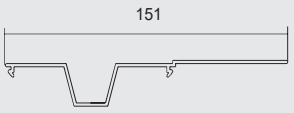
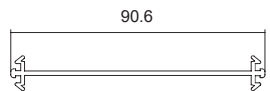
CODE	DESCRIPTION	LGTH.	FINISH	GROUP ID	
TJ359	Light Duty Sub Sill 12mm Set Back Slotted  1601,1930	6.5m	M/F CL/ANOD BZ/ANOD	10001 10002 10001	
TJ368	STD Sub Sill 6mm Set Back Slotted  1601,1930	6.5m	M/F CL/ANOD	10001 10002	
TJ379	Heavy Duty Sub Sill 12mm Set Back Slotted  1601,1930	6.5m	M/F CL/ANOD	10001 10002	
TJ259	Sub Sill 25mm Set Back Slotted  1601,1930	6.5m	M/F CL/ANOD BZ/ANOD	10001 10002 10001	
TJ432	Sub Sill 35mm Set Back Slotted  1601,1930	6.5m	M/F CL/ANOD	10001 10002	
TJ479	High Performance Sub Sill 22mm Set Back Slotted  1601	6.5m	M/F CL/ANOD	10001 10002	
TJ305	Flush Adaptor Fits with TJ301/302	6.5m	M/F CL/ANOD BZ/ANOD	8301 8302 8301	
TJ342	Reveal Clip-In Fits with TJ301/302	6.5m	M/F CL/ANOD	8301 8302	
TJ345	Fixing Adaptor Fits with TJ301	5.4m	M/F	8301	
TJ385	Back to Back Adaptor	6.5m	M/F	8301	

TO BE  
DISCONTINUED

 Key hardware.

# 165MM PATIO DOOR

	CODE	DESCRIPTION	LGTH.	FINISH	GROUP ID
	SWD610	165mm Patio Door Jamb Fits with SWD416/614/615 Flat Fillers TJ305/FGS417	5.4m	M/F CL/ANOD	10801 10802
	SWD611	165mm Patio Door Head Fits with SWD416 Flat Fillers TJ305/FGS417 1490, 1721	6.5m	M/F CL/ANOD	10801 10802
	SWD613	165mm Patio Door Sill (Slotted) 1491, 1685, 1721, FB1225-H	6.5m	M/F CL/ANOD	10801 10802
	SWD620	Patio Door Flush Stacker Fits with SWD220 & SWD320 1685, 1721, 1922, FB1225-H	6.5m	M/F CL/ANOD	10801
	FB1225-H	Sill Support with Drainage Holes Fits with SWD613/620	4.0m	M/F CL/ANOD	10802
	SWD614	165mm Patio Door Receiver Fits with SWD610 1721	5.4m	M/F CL/ANOD	10801 10802
	SWD615	165mm Patio Door Flyscreen Receiver Channel Fits with SWD610	5.4m	M/F CL/ANOD	10801 10802
	SWD621	165mm Patio Door Sub Head 1710, 1601	6.5m	M/F CL/ANOD	10801 10802
	SWD622	165mm Patio Door Subsill 1601	6.5m	M/F CL/ANOD	10801 10802

Key hardware.

Technical guidance recommended.







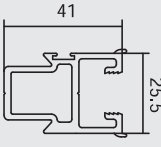

Wheelchair access friendly

# PATIO DOOR SECTIONS

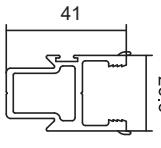
CODE	DESCRIPTION	LGTH.	FINISH	GROUP ID	
SW019	Head and Jamb Filler Fits with SWD036/411/412/414/611/614  1837	5.3m	M/F CL/ANOD	10601 10602	
		6.5m	M/F CL/ANOD	10801 10802	
SWD033	Threshold Fits with SWD413/420/613/620	6.5m	M/F CL/ANOD	10801 10802	
SW016	STD Interlock Fits with SW009/010/027  1672, 1830	4.6m	M/F CL/ANOD	10601 10602	
		5.4m	M/F CL/ANOD	10601 10602	
SW014	Small Box Interlock Fits with SW009/010/027  1672, 1831	4.6m	M/F CL/ANOD	10601 10602	
		5.4m	M/F CL/ANOD	10801 10802	
SW015	Large Box Interlock Fits with SW009/010/027  1672, 1832	4.6m	M/F CL/ANOD	10601 10602	
		5.4m	M/F CL/ANOD	10801 10802	
SWD030	Patio Door Heavy Duty Interlock Fits with SW009/010/027  1672, 1838	5.4m	M/F CL/ANOD	10801 10802	

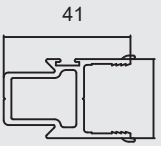
 Key hardware.

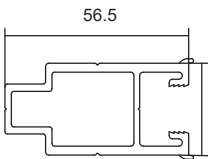
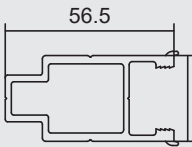
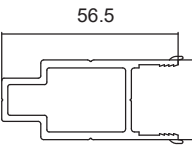
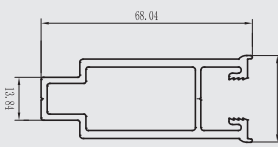
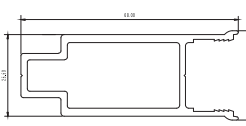
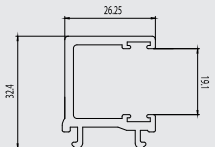
# PATIO DOOR SECTIONS

	CODE	DESCRIPTION	LGTH.	FINISH	GROUP ID
	SW009	Patio Door Interlock Stile Fits with SW014/015/016/SWD030 Suits up to 10mm Glass  1721	4.6m	M/F CL/ANOD	10601 10602
			5.4m		
	SW010	Patio Door Interlock Stile Fits with SW014/015/016/SWD030 Suits up to 16mm Glass  1721	4.6m	M/F CL/ANOD	10601 10602
			5.4m		
	SW027	Patio Door 20mm Double Glazed Interlock Stile Fits with SW014/015/016/SWD030 Suits up to 20mm Glass  1721	5.4m	M/F CL/ANOD	10801 10802
	SW022	Patio Door Male Stile Suits up to 10mm Glass	4.6m	M/F CL/ANOD	10601 10602
			5.4m		
	SW023	Patio Door Male Stile Suits up to 16mm Glass	4.6m	M/F CL/ANOD	10601 10602
			5.4m		
	SW029	Patio Door Male Stile Suits up to 20mm Glass	5.4m	M/F CL/ANOD	10801 10802
	SWD044	Patio Corner Stile - Male	5.4m	M/F	10801
	SWD045	Patio Corner D/G Stile - Male	4.5m	M/F	10801
	SWD623	Corner Meeting Stile  1721, 1842	5.4m	M/F	10801

 Key hardware.

CityView™ • Patio Door System

# PATIO DOOR SECTIONS

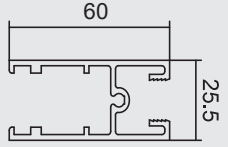
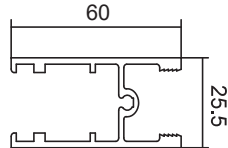
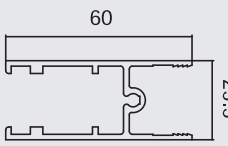
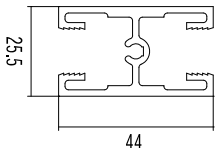
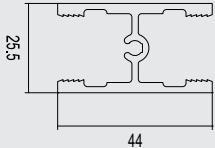
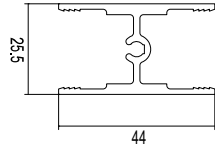
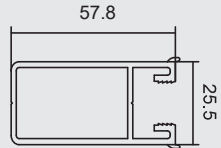
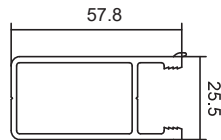
CODE	DESCRIPTION	LGTH.	FINISH	GROUP ID	
SW007	Patio Door Rail Suits up to 10mm Glass	5.3m	M/F CL/ANOD	10601 10602	
SW008	Patio Door Rail Suits up to 16mm Glass	5.3m	M/F CL/ANOD	10601 10602	
SW026	Patio Door Rail Suits up to 20mm Glass	6.5m	M/F CL/ANOD	10801 10802	
SWD041	Patio Door Standard Midrail	6.5m 6.5m	M/F CL/ANOD	10801 10802	
SWD042	Patio Door Standard Midrail Suits up to 16mm Glass	6.5m 6.5m	M/F CL/ANOD	10801 10802	
SWD043	Patio Door Standard Midrail Suits up to 20mm Glass	6.5m 6.5m	M/F CL/ANOD	10801 10802	
SW011	Patio Door Lock Stile Suits up to 10mm Glass	4.6m 5.4m	M/F CL/ANOD	10601 10602	
SW012	Patio Door Lock Stile Suits up to 16mm Glass	4.6m 5.4m	M/F CL/ANOD	10601 10602	

TO BE  
DISCONTINUED

TO BE  
DISCONTINUED

TO BE  
DISCONTINUED













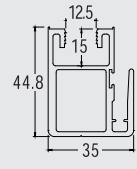

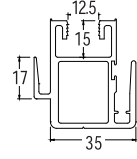

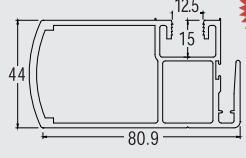

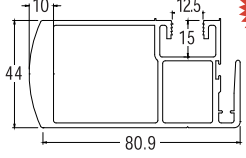
# PATIO DOOR SECTIONS

	CODE	DESCRIPTION	LGTH.	FINISH	GROUP ID
	SW028	Patio Door Lock Stile Suits up to 20mm Glass	5.4m	M/F CL/ANOD	10801 10802
	SW024	Female Adaptor Fits with SW009/SW010 1721	4.6m	M/F CL/ANOD	10601 10602
			5.4m	M/F CL/ANOD	10801 10802
	SWD031	Patio Door Heavy Duty Female Adaptor Fits with SW009/SW010 Accepts SW022/023/029 1721, 1839	5.4m	M/F CL/ANOD	10801 10802
	SWD032	Patio Door Medium Duty Female Adaptor Fits with SW009/SW010 Accepts SW022/023/029 1721, 1839	5.4m	M/F CL/ANOD	10801 10802
	SWD039	Patio Door FSF Adaptor Fits with SW009 1721, 1840	5.4m	M/F	10801
			5.4m	CL/ANOD	10802
	SWD038	Patio Door STD Interlock W' Flydoor Interlock Attached Fits with SW009 1672	5.4m	M/F	10801
			5.4m	CL/ANOD	10802
	SWD037	Patio Door Fly Door Interlock Fits with DF001 1675	5.4m	M/F	10801
			5.4m	CL/ANOD	10802
	SWD419	Patio Door Fly Door Raised Clip-on Track	6.5m	M/F CL/ANOD	10801 10802
	SWD619	Patio Door Fly Door Raised Clip-on Twin Track	6.5m	M/F CL/ANOD	10801 10802

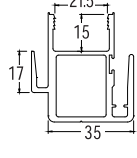
Key hardware.

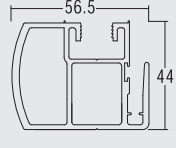
CityView™ • Patio Door System

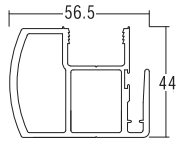
# PATIO DOOR SECTIONS - SINGLE PIECE





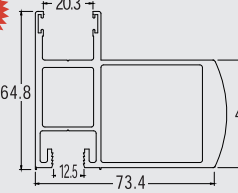



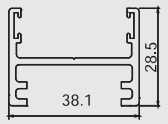

CODE	DESCRIPTION	LGTH.	FINISH	GROUP ID	
SWD050	Single Interlock Stile Single Glazed  1672, 1721, 1847, 1848	5.4m	M/F CL/ANOD	10802	 
SWD051	Single Interlock with Fly Stile Single Glazed  1672, 1721, 1847, 1848	5.4m	M/F CL/ANOD	10802	 
SWD052	Single Interlock Box Stile Single Glazed  1672, 1721, 1847, 1848, 1849	5.4m	M/F CL/ANOD	10802	 
SWD053	Single Interlock H/D Box Stile Single Glazed  1672, 1721, 1847, 1848, 1849	5.4m	M/F CL/ANOD	10802	 
SWD060	Single Interlock Stile Double Glazed  1672, 1721, 1847, 1848	5.4m	M/F CL/ANOD	10802	 
SWD061	Single Interlock with Fly Stile Double Glazed  1672, 1721, 1847, 1848	5.4m	M/F CL/ANOD	10802	 
SWD058	Small Box Interlock Single Glazed  1721	6.5m	M/F CL/ANOD	10801 10802	 
SWD068	Small Box Interlock Double Glazed  1721	6.5m	M/F CL/ANOD	10801 10802	 

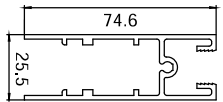
# PATIO DOOR SECTIONS - SINGLE PIECE

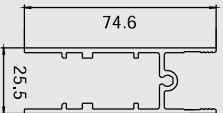
	CODE	DESCRIPTION	U.O.M.	BOX QTY.	GROUP ID
 	SWD062	Single Interlock Box Stile Double Glazed  1672, 1721, 1847, 1848, 1849	5.4m	M/F CL/ANOD	10802
 	SWD063	Single Interlock H/D Box Stile Double Glazed  1672, 1721, 1847, 1848, 1849	5.4m	M/F CL/ANOD	10802
 	SWD055	H/D Female Adapter Single Glazed  1672, 1721, 1849	5.4m	M/F CL/ANOD	10802
 	SWD065	H/D Female Adapter Double Glazed  1672, 1721, 1849	5.4m	M/F CL/ANOD	10802
 	SWD057	Male Stile Single Glazed	5.4m	M/F CL/ANOD	10802
 	SWD067	Male Stile Double Glazed	5.4m	M/F CL/ANOD	10802
 	SWD056	Stile Single Glazed	5.4m	M/F CL/ANOD	10802
 	SWD066	Stile Double Glazed	5.4m	M/F CL/ANOD	10802

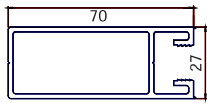
CityView™ • Patio Door System

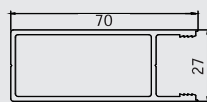
# PATIO DOOR SECTIONS - SINGLE PIECE

CODE	DESCRIPTION	LGTH.	FINISH	GROUP ID		
SWD444	Patio Meeting Stile Plant On  1721	5.4m	M/F CL/ANOD	10802		
SWD220	Tall Rail Single Glazed Suits with SWD420/620	5.4m	M/F CL/ANOD	10802		
SWD320	Tall Rail Double Glazed Suits with SWD420/620	5.4m	M/F CL/ANOD	10802		
SWD256	Wide Stile Single Glazed	5.4m	M/F CL/ANOD	10802		
SWD266	Wide Stile Double Glazed	5.4m	M/F CL/ANOD	10802		



# PATIO DOOR HARDWARE





	CODE	DESCRIPTION	U.O.M.	BOX QTY.	GROUP ID
	1670	Glazing Channel To Suit 6.38mm Glass - 100m Roll	Roll	N/A	16169
	1604	Glazing Channel To Suit 8.38mm Glass - 100m Roll	Roll	N/A	654
	1671	Glazing Channel To Suit 10.38mm Glass - 100m Roll	Roll	N/A	16169
	1666	Glazing Channel To Suit 12.38mm Glass - 40m Roll	Roll	N/A	16109
	1689	16mm Glazing Channel Suits SW027/29/26/43	Roll	N/A	16169
	1667	Glazing Channel To Suit 18mm Glass - 75m Roll	Roll	N/A	16169
	1677	Glazing Channel To Suit 20mm Glass - 80m Roll	Roll	N/A	16169
	1661	Glazing Channel To Suit 20.4mm Glass - 100m Roll	Roll	N/A	16169
	1672	Interlock Cushion - 100m Roll	Roll	N/A	16169
	1685	Sill Flap / Insert - 300m Roll	Roll	N/A	16169
	1685- COEX	Sill Flap / Insert Co-Extruded - 200m Roll	Roll	1	16169
	1721	Weatherstrip 69-525 Black with Fin - 400m Roll	Roll	5	16173
	2642	Foam Seal - Slide in 500m Roll (Everton)	Roll	N/A	16177

CityView™ • Patio Door System

# PATIO DOOR HARDWARE



## ANTHONY INNOVATIONS PATIO DOOR HARDWARE

CODE	DESCRIPTION	U.O.M.	BOX QTY.	GROUP ID	
1800	Anthony Innovations 9017NA Roller for Single Wheel Patio Door - 40kg	Each	100	16149	
1801	Anthony Innovations 9017DNA Roller for Dual Wheel Patio Door - 80kg	Each	100	16149	
1802	Anthony Innovations TraXtar Duo, high performance - 110kg	Each	50	16149	
1808	Anthony Innovations Quad Roller 150kg	Each	20	16149	
1803	Fixed Panel Adjustment Block	Each	100	16149	

## PATIO DOOR HARDWARE

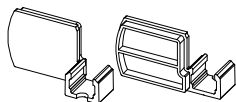
CODE	DESCRIPTION	U.O.M.	BOX QTY.	GROUP ID	
1836	Fixing Clip to Suit Patio Interlock Bag of 500	Bag	N/A	16109	
1834	Hole Plug 10mm Bag of 200	Bag	N/A	16109	
1912	Setting Block / Fixed Panel Spacing Block Bag of 500	Bag	N/A	16157	
1830	Filler Block For SW016 Bag of 20	Bag	N/A	16109	
1831	Filler Block For SW014 Bag of 10 Pairs	Bag	N/A	16109	
1832	Filler Block For SW015 Bag of 10 Pairs	Bag	N/A	16109	

# PATIO DOOR HARDWARE

	CODE	DESCRIPTION	U.O.M.	BOX QTY.	GROUP ID
	1837	End Cap to Suit Patio Door Threshold - Black	20 pieces p/bag	N/A	16109
	1838	End Caps to Suit Patio Door Interlocks - SWD030 - Black	10 pairs p/bag	N/A	16109
	1839	End Caps to Suit Patio Door Interlocks - SWD031/032 - Black	10 pairs p/bag	N/A	16109
	1840	End Caps to Suit Patio Door Interlocks - SWD039 - Black	10 pairs p/bag	N/A	16109
	1842	Patio Corner Door Block (L & R)	10 pairs p/bag	N/A	16109
	1847	Single Interlock Fixed Panel Block SWD050/51/52/53/60/61/62/63	10 pairs p/bag	N/A	16109
	1848	Single Interlock Filler Block SWD050/51/52/53/60/61/62/63	10 pairs p/bag	N/A	16109
	1856	Flush Sill Interlock Filler Block SWD050/51/52/53/60/61/62/63	10 pairs p/bag	N/A	16109
	1849	Single Interlock End Cap SWD052/53/55/62/63/65	10 pieces p/bag	N/A	16109
	1841	Single Interlock End Cap Suits SWD058	10 pairs p/bag	N/A	16109
	1488	Foam Seal - 905 Pieces Roll Fits with SWD411 Head	Roll	N/A	16177
	1489	Foam Seal - 500 Pieces Roll Fits with SWD413 Sill	Roll	N/A	16177
	1490	Foam Seal - 905 Pieces Roll Fits with SWD611 Head	Roll	N/A	16177
	1491	Foam Seal - 695 Pieces Roll Fits with SWD613 Sill	Roll	N/A	16177
	1990	Sill Plug (Black) - 60 Plugs & 20 Slotted	80 pieces p/bag	N/A	16109
	1675	Flydoor Interlock Infill - 100m Roll	Roll	N/A	16169

CityView™ • Patio Door System

# PATIO DOOR HARDWARE



## LOCKWOOD ONYX & ACCESSORIES

CODE	DESCRIPTION	U.O.M.	BOX QTY.	GROUP ID
1252-**	ONYX Lock - D Inner/Slim Outer, 5 Pin Cyl - K/D, Surface Strike <i>**Specify finish: Black-BL, Silver-SCA</i>	Each	10	16149
1352-**	ONYX Lock - D Inner/Slim Outer, 5 Pin Cyl - K/N J031, Surface Strike <i>**Specify finish: Black-BL, Silver-SCA</i>	Each	10	16149
1253	ONYX Lock-D Inner/Slim Outer, 5 Pin Cyl - K/D, Surface Strike Satin Chrome	Each	10	16149
1254-**	ONYX Lock - Slim Inner/Slim Outer, 5 Pin Cyl- K/D, Surface Strike <i>**Specify finish: Black-BL, Silver-SCA</i>	Each	10	16149
1354-**	ONYX Lock - Slim Inner/Slim Outer, 5 Pin Cyl- K/N J031, Surface Strike <i>**Specify finish: Black-BL, Silver-SCA</i>	Each	10	16149
1255	ONYX Lock - Slim Inner/Slim Outer, 5 Pin Cyl- K/D, Surface Strike Satin Chrome	Each	10	16149
1256	ONYX Extra Wide Strike - Black	Each	10	16149
1257	ONYX Extra Wide Strike - Satin Chrome	Each	10	16149
1260-BL	ONYX Lock Handle Packer - Black	Each	10	16149
1260-SCA	ONYX Lock Handle Packer - Silver	Each	10	16149
1261	ONYX Lock Handle Packer - Satin Chrome	Each	10	16149



## AUSTRAL YARRA VIEW & CYLINDERS

CODE	DESCRIPTION	U.O.M.	BOX QTY.	GROUP ID
1258-**	Yarra View Edge Sliding Door Lock Need 2 Cylinders 1268 or 1269 to go with Lock. <i>**Specify finish: Black-BL, Silver-SCA</i>	Each	5	16149
1258-SCA-25	Yarra View Edge Sliding Door Lock with 25mm Striker Plate	Each	N/A	16149
1258-BLK-25	Yarra View Edge Sliding Door Lock with 25mm Striker Plate	Each	N/A	16149
1358-BL	Yarra View Ridge Sliding Glass Door Deadlock - Black	Each	N/A	16149
1268	C4 5 Pin Cylinder Yarra View - K/Alike - Single Cylinder Only, Key No Is 249	Bag	10	16149
1269	C4 5 Pin Cylinder Yarra View - K/Differ - Single Cylinder Only	Bag	10	16149
1269-KAP	C4 5 Pin Cylinder Yarra View - K/Alike In Pairs for Double Cylinders Lock	Bag	5	16149



Please check with your local branch for stock availability.



# PATIO DOOR HARDWARE



## AUSTRAL YARRA LOCKS & CYLINDERS

	CODE	DESCRIPTION	U.O.M.	BOX QTY.	GROUP ID
 	1262-BLS	Yarra Single Beak Sliding Patio Lock Single Cylinder 16mm Catch Black	Each	N/A	16149
	1263-BLS	Yarra Single Beak Sliding Patio Lock Single Cylinder 25mm Catch Black	Each	N/A	16149
 	1262-BLD	Yarra Single Beak Sliding Patio Lock Double Cylinder 16mm Catch Black	Each	N/A	16149
	1263-BLD	Yarra Single Beak Sliding Patio Lock Double Cylinder 25mm Catch Black	Each	N/A	16149
 	1264	4mm Handle Packer for Yarra Essential	Each	N/A	16149

	CODE	DESCRIPTION	U.O.M.	BOX QTY.	GROUP ID
	1900-M	Frame Packers - 1.5mm X 90mm. Blue 100/Bag	Bag	N/A	16157
	1901-M	Frame Packers - 3mm X 90mm. Green 100/Bag	Bag	N/A	16157
	1902-M	Frame Packers - 5mm X 90mm. Ochre 100/Bag	Bag	N/A	16157
	1903-M	Frame Packers - 10mm X 90mm. Black 100/Bag	Bag	N/A	16157
	1906	Aluminium Frame Packers 1mm. 100/Bag	Bag	N/A	6149
	1907	Aluminium Frame Packers 2mm. 100/Bag	Bag	N/A	6149
	1908	Aluminium Frame Packers 5mm. 100/Bag	Bag	N/A	6149
	1909	Aluminium Frame Packers 10mm. 100/Bag	Bag	N/A	6149
	1910	Setting Blocks 3mm Thick - Bag of 1,000	Bag	N/A	16157
	1911	Setting Blocks 5mm Thick - Bag of 1,000	Bag	N/A	16157
	1912	Setting Blocks 10mm Thick - Bag of 500	Bag	N/A	16157
	1977	Setting Blocks 5mm X 25mm - 3m Self Adhesive - Bag of 200	Bag	N/A	17320
	1978	Setting Blocks 10mm X 25mm - 3m Self Adhesive - Bag of 200	Bag	N/A	17320
	1979	Setting Blocks 3mm X 10mm X 25mm - 3m Double Sided Tape - Bag of 200	Bag	N/A	17320
	1930	End Cap to Suit Subsills Bag of 50 Pairs - Left + Right	Bag	N/A	16157



Please check with your local branch for stock availability.

# SYSTEM TOOLING

## CODE DESCRIPTION

DTL3106 101.6mm Sliding Window / Patio Door Drilling Jig  
Suits SW009/010/011/012/022/023



DTL3107 Stepped Drill Bit  
To Suit DT3106 Jig



DTL3110-  
AIR Sliding Window / Patio Door Air Operated Tool



DTL3112 101.6mm Patio Door Dr & Sliding Window Jamb Tool



DTL3113 165mm Patio Door Jamb Tool

DTL3114 101.6mm Patio Door Jamb Drill Jig Set (Head & Sill)



DTL3115 165mm Patio Door Jamb Drill Jig Set (Head & Sill)

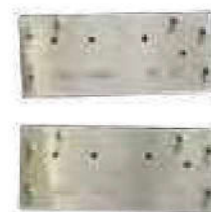



## ARCHITECTURAL SLIDING DOOR SYSTEM

### 101.6/152.4/203.2 MM ARCHITECTURAL SLIDING DOOR

GLASS THICKNESS	SPECIFIC PROFILES REQUIRED	CHANNEL RUBBER REQUIRED	POCKET SIZE
6mm		1670	12.5mm
8mm		1604	
10mm		1671	
12mm		1665	30mm
24mm		1674	
28mm		1669	
30mm	SD157 adapter WITH DG system	1654	33mm



1604



1654



1665

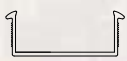

1669



1670





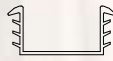







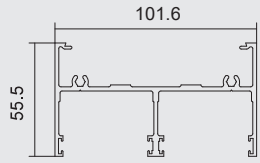

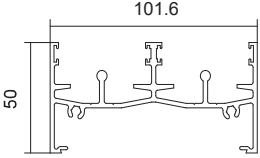

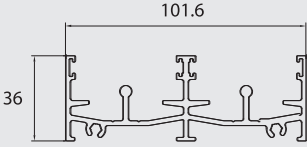

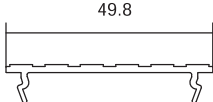

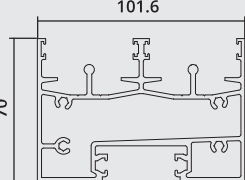

1671

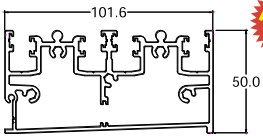

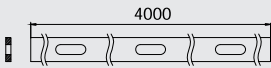
1674

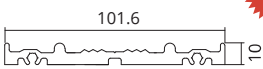

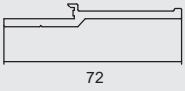
# 101.6MM ARCHITECTURAL SLIDING DOOR

CODE	DESCRIPTION	LGTH.	FINISH	GROUP ID	
SD401	Door Head  1478, 1721	6.5m	M/F CL/ANOD	10401 10402	
SD402	Door Sill - Slotted  1478, 1721, 1818	6.5m	M/F CL/ANOD	10401 10402	
SD403	36mm Door Sill - (Not slotted)  1721	6.5m	M/F	10401	
SD603	Universal Threshold Fits with SD402/403/405/408  1598	6.5m	M/F CL/ANOD	10401 10402	
SD405	Sill with Low Lite  1721	6.5m	M/F	10401	 
SD408	Flush Door Sill - Slotted Fits with SD149/169   1721, 1926, FB1225-H	6.5m	M/F	10401 10402	 
FB1225-H	Sill Support with Drainage Holes Fits with SD408	4.0m	M/F CL/ANOD	10802	
SD409	Apartment Door 101.6 x 100mm Wheelchair Sill 	6.5m	M/F CL/ANOD	10401	 
SD469	High Performance Sill Riser Fits with SD402/602	6.5m	M/F CL/ANOD	10401 10402	 







Key hardware.

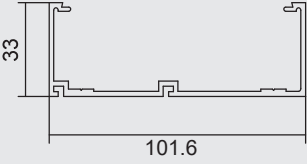
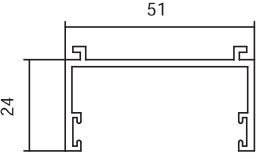

Wheelchair access friendly

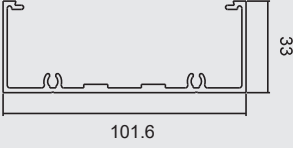
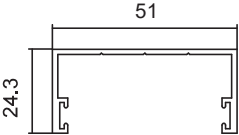

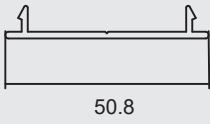







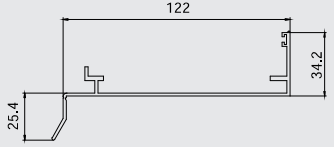

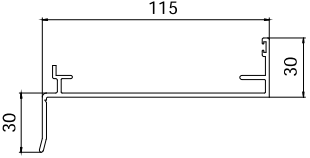

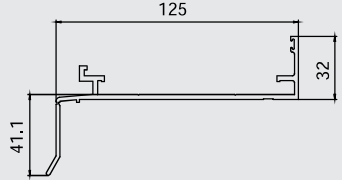
# 101.6MM ARCHITECTURAL SLIDING DOOR

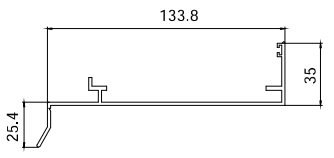
	CODE	DESCRIPTION	LGTH.	FINISH	GROUP ID
	SD400	Jamb Fits with SD468	6.5m	M/F CL/ANOD	10401 10402
	SD468	Slide In Jamb Adaptor Fits with SD400/600/800  1721	6.5m	M/F CL/ANOD	10401 10402
	SD100	101.6mm Plain Jamb	6.5m	M/F CL/ANOD	10401 10402
	SD111	Screw Fix Jamb Adaptor Fits with SD100/150  1721	6.5m	M/F CL/ANOD	10401 10402
	SD128	Head/Jamb Track Filler Fits SD111/401/468	6.5m	M/F CL/ANOD	10401 10402

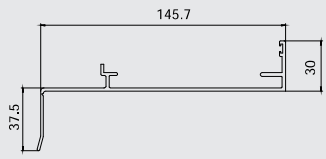

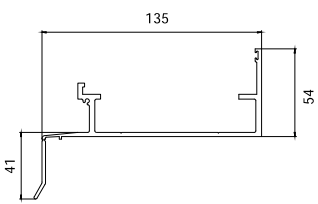
 Key hardware.

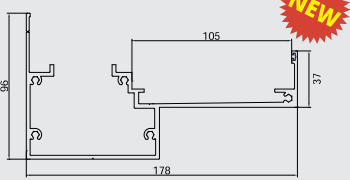
# 101.6MM ARCHITECTURAL SLIDING DOOR

CODE	DESCRIPTION	LGTH.	FINISH	GROUP ID	
TJ359	Light Duty Sub Sill 12mm Set Back Slotted  1601,1930	6.5m	M/F CL/ANOD BZ/ANOD	10001 10002 10001	
TJ368	STD Sub Sill 6mm Set Back Slotted  1601,1930	6.5m	M/F CL/ANOD	10001 10002	
TJ379	Heavy Duty Sub Sill 12mm Set Back Slotted  1601,1930	6.5m	M/F CL/ANOD	10001 10002	
TJ259	Sub Sill 25mm Set Back Slotted  1601,1930	6.5m	M/F CL/ANOD BZ/ANOD	10001 10002 10001	
TJ432	Sub Sill 35mm Set Back Slotted  1601,1930	6.5m	M/F CL/ANOD	10001 10002	
TJ479	High Performance Sub Sill 22mm Set Back Slotted  1601 	6.5m	M/F CL/ANOD	10001 10002	
TJ400	Drain Sump  1601,1912, TJ404L, TJ404R	6.5m	M/F	10001 10002	 

TO BE  
DISCONTINUED

 Key hardware.





 Technical guidance recommended.

# 101.6MM ARCHITECTURAL SLIDING DOOR

	CODE	DESCRIPTION	LGTH.	FINISH	GROUP ID
	TJ309	49mm Sub Head Key hardware: 1601, 1710	6.5m	M/F CL/ANOD BZ/ANOD	10001 10002 10001
	TJ399	Heavy Duty Sub Head Key hardware: 1601, 1710	6.5m	M/F CL/ANOD	10001 10002
	TJ692	80mm Sub Head Key hardware: 1601, 1710	6.5m	M/F CL/ANOD	10001 10002
	TJ520	120mm Sub Head Key hardware: 1601, 1710	6.5m	M/F	10001 10002
	TJ430	Two Part Sub Head Fits with TJ429 Key hardware: 1601	6.5m	M/F CL/ANOD	10001 10002
	TJ429	Sub Head Cover Fits with TJ430 Key hardware: 1601	6.5m	M/F CL/ANOD	10001 10002
	TJ431	Standard Two Part Subhead / Jamb Fits with TJ6159 Key hardware: 1601	6.5m	M/F CL/ANOD	10001 10002
	TJ6159	Sub Head / Jamb Cover Fits with TJ431 Key hardware: 1601	6.5m	M/F CL/ANOD	10001 10002

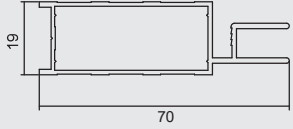
 Key hardware.

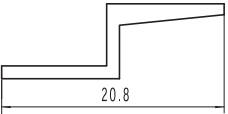
# 101.6MM ARCHITECTURAL SLIDING DOOR

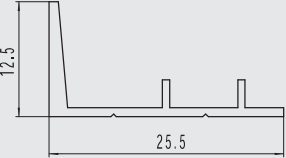
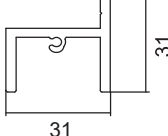
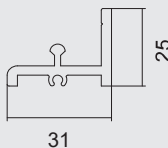
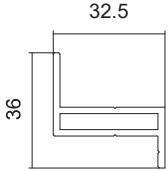
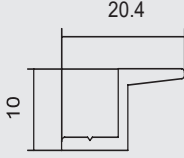
CODE	DESCRIPTION	LGTH	FINISH	GROUP ID	
DF001	Standard Security Door Frame  2650, 2651	6.0m	M/F CL/ANOD	2106 2106	
DI3224	7mm Offset Interlock  <b>FOR NSW ONLY</b>	4.3m 4.8m	M/F CL/ANOD	2146 2146	
DI3225	Frame Interlock  <b>FOR NSW ONLY</b>	4.3m 4.8m	M/F CL/ANOD	2146 2146	
SD421	Single Fly Door Head	6.5m	M/F CL/ANOD	10401 10402	
SD422	Single Fly Door Sill	6.5m	M/F CL/ANOD	10401 10402	
SD425	Single Fly Door Jamb	6.5m	M/F CL/ANOD	10401 10402	
SD626	10mm Interlock	6.5m	M/F CL/ANOD BZ/ANOD	10401 10402 10401	

 Key hardware.

 Please check with your local branch for stock availability.





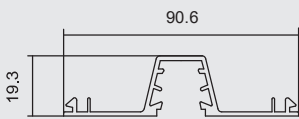
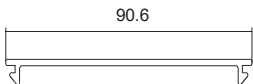
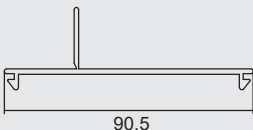
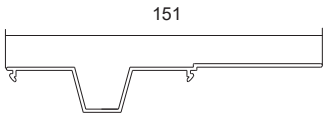
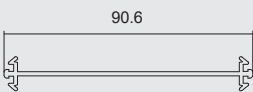
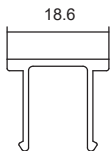



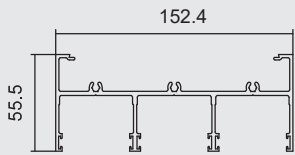

# 101.6MM ARCHITECTURAL SLIDING DOOR

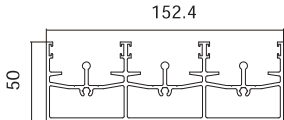
	CODE	DESCRIPTION	LGTH.	FINISH	GROUP ID
	TJ304	Glazing Adaptor	6.5m	M/F CL/ANOD BZ/ANOD	8301 8302 8301
	TJ305	Flush Adaptor	6.5m	M/F CL/ANOD BZ/ANOD	8301 8302 8301
	TJ342	Reveal Clip-In	6.5m	M/F	8301
	TJ345	Fixing Adaptor	5.4m	M/F	8301
	TJ385	Back to Back Adaptor	6.5m	M/F	8301
	TJ307	Flush Pocket Filler Fits with TJ300/301/390/320/333/360/ TJ362/304/344/364/308	6.5m	M/F CL/ANOD BZ/ANOD	8301 8302 8301

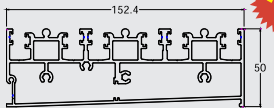
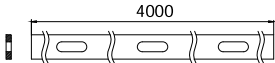

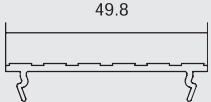
# 152.4MM ARCHITECTURAL SLIDING DOOR

CODE	DESCRIPTION	LGTH.	FINISH	GROUP ID	
SD601	Door Head  1721, 1476	6.5m	M/F CL/ANOD	10401 10402	
SD605	Closed Sill - Slotted  1721, 1477	6.5m	M/F CL/ANOD	10401 10402	
SD608	Flush Sill - Slotted Fits with SD146/169  1721, 1926, FB1225-H 	6.5m	M/F	10401 10402	
FB1225-H	Sill Support with Drainage Holes Fits with SD608	4.0m	M/F CL/ANOD	10802	
SD603	Universal Threshold Fits SD605/608  1598	6.5m	M/F CL/ANOD	10401 10402	
SD609	Apartment Door 152.4 x 10mm Wheelchair Sill 	6.5m	M/F CL/ANOD	10401	



Key hardware.







Technical guidance recommended.

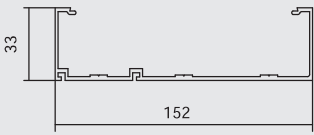
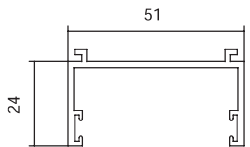

Wheelchair access friendly

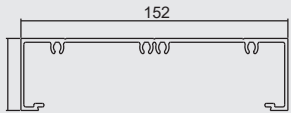
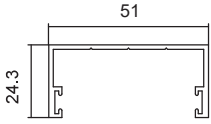
# 152.4MM ARCHITECTURAL SLIDING DOOR

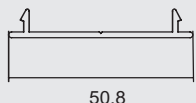
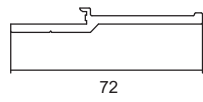







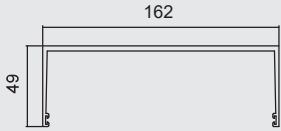

	CODE	DESCRIPTION	LGTH.	FINISH	GROUP ID
	SD600	Jamb Fits with SD468	6.5m	M/F CL/ANOD	10401 10402
	SD468	Slide In Jamb Adaptor Fits with SD400/600/800  1721	6.5m	M/F CL/ANOD	10401 10402
	SD150	150mm Frame	6.5m	M/F CL/ANOD	10401 10402
	SD111	Screw Fix Jamb Adaptor Fits with SD100/150  1721	6.5m	M/F CL/ANOD	10401 10402
	SD128	Head/Jamb Track Filler Fits with SD111/468/601	6.5m	M/F CL/ANOD	10401 10402
	SD469	High Performance Sill Riser Fits with SD402/602	6.5m	M/F CL/ANOD	10401 10402

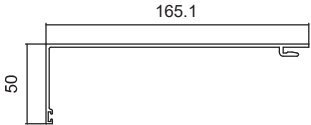
**TO BE  
DISCONTINUED**

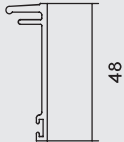

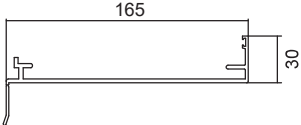

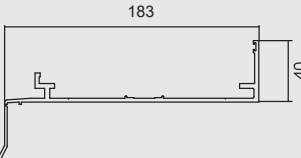

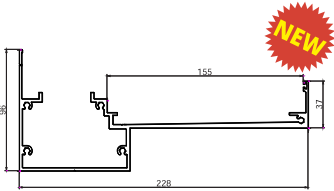
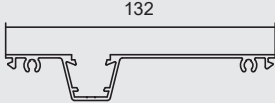
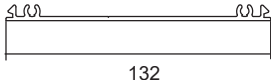

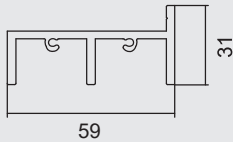
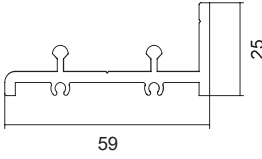

 Key hardware.

# 152.4MM ARCHITECTURAL SLIDING DOOR

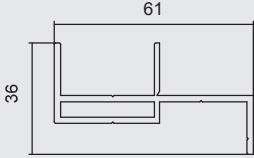
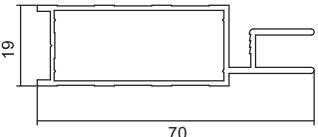
CODE	DESCRIPTION	LGTH.	FINISH	GROUP ID	
TJ6157	150mm Sub Head  1710, 1601	6.5m	M/F CL/ANOD	10001 10002	
TJ6158	150mm Sub Head Fits with TJ6159  1601	6.5m	M/F CL/ANOD	10001 10002	
TJ6159	150mm Sub Head Adaptor Fits with TJ6158  1601	6.5m	M/F CL/ANOD	10001 10002	
TJ6156	150mm Sub Sill Slotted  1601	6.5m	M/F CL/ANOD	10001 10002	
TJ679	High Performance 150mm Sub Sill Slotted  1601	6.5m	M/F CL/ANOD	10401 10402	
TJ600	Drain Sump  1601, 1912, TJ604L, TJ604R	6.5m	M/F CL/ANOD	10401 10402	
TJ6164	50mm Offset Adaptor	6.5m	M/F CL/ANOD	8501 8502	
JM2865	132mm Flat Filler	6.5m	M/F CL/ANOD	8701 8702	

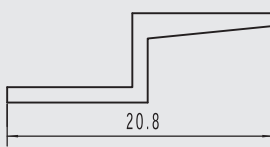
 Key hardware.

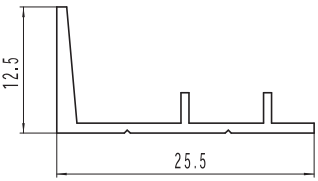
# 152.4MM ARCHITECTURAL SLIDING DOOR

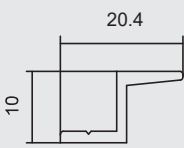
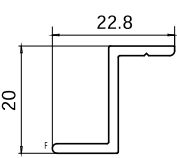





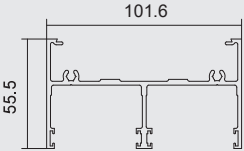

	CODE	DESCRIPTION	LGTH.	FINISH	GROUP ID
	SD621	Double Fly Door Head	6.5m	M/F CL/ANOD	10401 10402
	SD622	Double Fly Door Sill 	6.5m	M/F CL/ANOD	10401 10402
	SD625	Double Fly Door Jamb	6.5m	M/F CL/ANOD	10401 10402
	DF001	Standard Security Door Frame  2650, 2651	6.5m	M/F CL/ANOD	2106 2106
	DI3224	7mm Offset Interlock 	4.3m 4.8m	M/F CL/ANOD	2146 2146
	DI3225	Frame Interlock 	4.3m 4.8m	M/F CL/ANOD	2146 2146
	SD626	10mm Interlock	6.5m	M/F CL/ANOD BZ/ANOD	10401 10402 10401
	SD620	20mm Interlock Suits FS screening in SD605	6.5m	M/F CL/ANOD	10401 10402

 Key hardware.

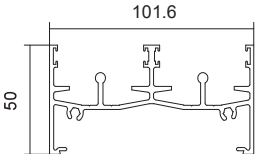
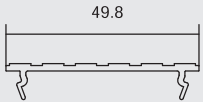
 Technical guidance recommended.

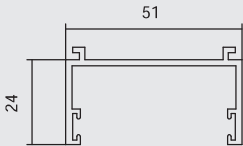
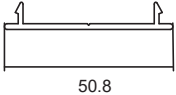
 Please check with your local branch for stock availability.

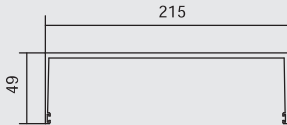
# 203.2MM ARCHITECTURAL SLIDING DOOR

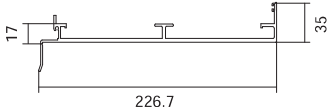
CODE	DESCRIPTION	LGTH.	FINISH	GROUP ID	
SD401	Door Head  1478, 1721	6.5m	M/F CL/ANOD	10401 10402	
SD402	Door Sill - Slotted  1478, 1721	6.5m	M/F CL/ANOD	10401 10402	
SD603	Universal Threshold Fits SD402	6.5m	M/F CL/ANOD	10401 10402	
SD800	Jamb Fits with SD468/TJ305	6.5m	M/F CL/ANOD	10401 10402	
SD468	Jamb Adaptor Fits with SD400/600/800  1721	6.5m	M/F CL/ANOD	10401 10402	
SD128	Head/Jamb Track Filler Fits with SD401/468	6.5m	M/F CL/ANOD	10401 10402	
TJ805	Sub Head  1710, 1601	6.5m	M/F CL/ANOD	10001 10002	
TJ806	Sub Sill  1601, 1685	6.5m	M/F CL/ANOD	10001 10002	

 Key hardware.

# ARCHITECTURAL SLIDING DOOR SECTIONS

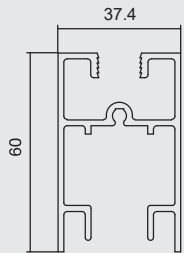
	CODE	DESCRIPTION	LGTH.	FINISH	GROUP ID
	SD104	Raked Top Rail	6.5m	M/F CL/ANOD	10401 10402
	SD110	Raked Mid Rail	6.5m	M/F CL/ANOD	10401 10402
	SD119	Square Rail	6.5m	M/F CL/ANOD	10401 10402
	SD123	Square Mid Rail	6.5m	M/F CL/ANOD	10401 10402
	SD120	DVG Adaptor Fits with SD119	6.5m	M/F CL/ANOD	10401 10402
	SD149	Tall Square Rail Suits SD408/608	6.5m	M/F CL/ANOD	10401 10402

**TO BE DISCONTINUED**

**NEW**

CityView™ • Arch. Sliding Door System



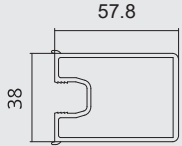
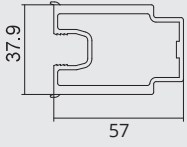
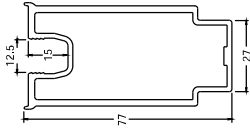





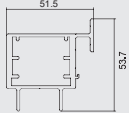
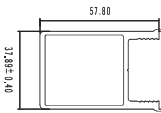
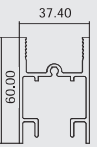

# ARCHITECTURAL SLIDING DOOR SECTIONS

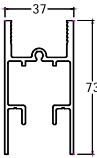
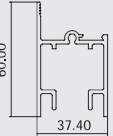
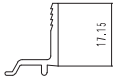
CODE	DESCRIPTION	LGTH.	FINISH	GROUP ID	
SD105	Plain Stile	6.5m	M/F CL/ANOD	10401 10402	
		2.8m	M/F CL/ANOD	10401 10402	
SD106	Interlock Fits with SD137/139  1672, 1721	6.5m	M/F CL/ANOD	10401 10402	
		2.8m	M/F CL/ANOD	10401 10402	
SD137	Box Interlock Fits with SD106/139  1672, 1678, 1721	6.5m	M/F CL/ANOD	10401 10402	
		2.8m	M/F CL/ANOD	10401 10402	
SD139	Heavy Duty Box Interlock 150mm Fits with SD106/137  1672, 1679, 1721	6.5m	M/F CL/ANOD	10401 10402	
		2.8m	M/F CL/ANOD	10401 10402	
SD141	Male Meeting Stile Fits with SD109/136	6.5m	M/F CL/ANOD	10401 10402	
SD161	Wide Male Meeting Stile Fits with SD109/136/164	6.5m	M/F CL/ANOD	10401 10402	
SD162	Wide Stile	6.5m	M/F CL/ANOD	10401 10402	
SD109	Female Meeting Stile Fits with SD141  1721	6.5m	M/F CL/ANOD	10401 10402	
SD136	Heavy Duty Female Meeting Stile Fits with SD141/161  1679, 1721	6.5m	M/F CL/ANOD	10401 10402	

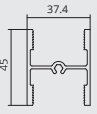
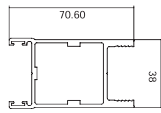
 Key hardware.

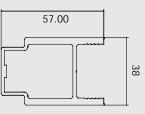



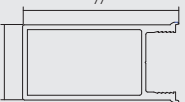



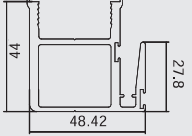

# ARCHITECTURAL SLIDING DOOR SECTIONS

	CODE	DESCRIPTION	LGTH.	FINISH	GROUP ID
	SD131	OXO Adaptor Fits with SD106/125/131/137/139/152	6.5m	M/F CL/ANOD	10401 10402
	SD124	Double Glazed Lock Stile	6.5m	M/F CL/ANOD	10401 10402
	SD127	Double Glazed Apartment Door Rail	6.5m	M/F CL/ANOD	10401 10402
 	SD169	Tall Double Glazed Rail Suits SD408/608	6.5m	M/F CL/ANOD	10401 10402
	SD142	Double Glazed Beaded Rail Fits with SD143	6.5m	M/F CL/ANOD	10401 10402
	SD143	Double Glazed Rail Bead Fits with SD142	6.5m	M/F CL/ANOD	10401 10402
 	SD148	Double Glazed Apartment Door Midrail	6.5m	M/F	10401
	SD145	Double Glazed Female Bipart Fits with SD146	6.5m	M/F CL/ANOD	10401 10402
 1721					
	SD146	Double Glazed Male Bipart Fits with SD145/153	6.5m	M/F CL/ANOD	10401 10402
 	SD170	Double Glazed Wide Male Stile Fits with SD145/153/164	6.5m	M/F CL/ANOD	10401 10402
 	SD172	Double Glazed Wide Stile	6.5m	M/F CL/ANOD	10401

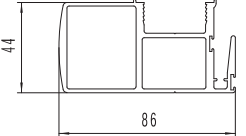
 Key hardware.

 Please check with your local branch for stock availability.

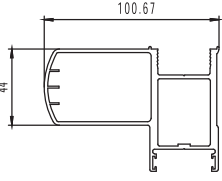
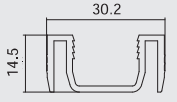
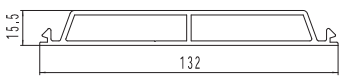
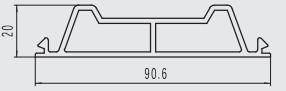
# ARCHITECTURAL SLIDING DOOR SECTIONS

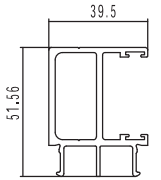
CODE	DESCRIPTION	LGTH.	FINISH	GROUP ID	
SD125	Double Glazed STD Interlock  1721, 1672	6.5m	M/F CL/ANOD	10401 10402	
SD151	Double Glazed Box Interlock Stile  1672, 1678, 1721	6.5m	M/F CL/ANOD	10401 10402	
SD152	Double Glazed Heavy Duty Box Interlock Stile  1672, 1679, 1721	6.5m	M/F CL/ANOD	10401 10402	
SD153	Double Glazed Heavy Duty Female Meeting Stile Fits with SD146  1679, 1721	6.5m	M/F CL/ANOD	10401 10402	
SD132	12.76mm Glazing Channel and 10.76mm Glazing Adaptor Fits with SD124	6.5m	M/F	10401 10402	
SD627	Apartment Door Sill Brace Suits 150mm track Fits SD602	4m	M/F	10401	
SD628	Apartment Door Sill Brace Suits 101.6mm track	4m	M/F	10401	
SD164	Corner Meeting Stile Female Suits SD109/SD145 Mates with SD161/170  1721, 1904 	6.5m	M/F	10401 10402	

TO BE DISCONTINUED









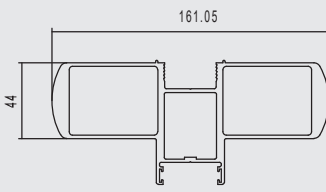

Key hardware.

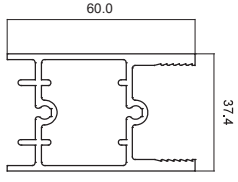
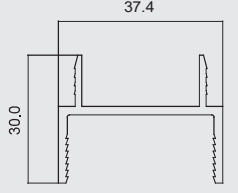
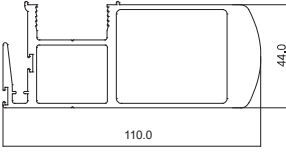

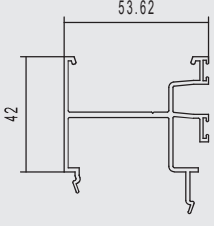
Technical guidance recommended.

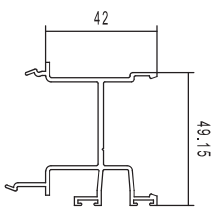
# ARCH. SLIDING DOOR SECTIONS - HIGH PERFORMANCE

	CODE	DESCRIPTION	LGTH.	FINISH	GROUP ID
	SD155	Double Box Female  1679, 1721	6.5m	M/F	10401
	SD156	Heavy Duty Box Rail	6.5m	M/F	10401
	SD157	33mm Double Glazed Adaptor	6.5m	M/F	10401
	SD158	Extra Heavy Duty Large Box Interlock  1672, 1679, 1721	6.5m	M/F	10401
	SD159	High Performance External Threshold  1694 	6.5m	M/F	10401
	SD160	High Performance Internal Threshold Suits SD603  1694 	6.5m	M/F	10401











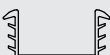

 Key hardware.

 Technical guidance recommended.

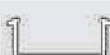
\* The high performance door sections are available ex-mill only.





# ARCHITECTURAL SLIDING DOOR HARDWARE

## ARCHITECTURAL SLIDING DOOR HARDWARE

CODE	DESCRIPTION	U.O.M.	BOX QTY.	GROUP ID	
1670	Glazing Channel To Suit 6.38mm Glass - 100m Roll	Roll	N/A	16169	
1604	Glazing Channel To Suit 8.38mm Glass - 100m Roll	Roll	N/A	654	
1671	Glazing Channel To Suit 10.38mm Glass - 100m Roll	Roll	N/A	16169	
1665	Glazing Channel To Suit 12.38mm Glass - 40m Roll	Roll	N/A	16169	 <b>NEW</b>
1674	Glazing Channel To Suit 24mm Glass - 50m Roll	Roll	N/A	16169	
1669	Glazing Channel To Suit 28mm Glass - 60m Roll	Roll	N/A	16169	
1654	Glazing Channel To Suit 30mm Glass - 40m Roll	Roll	N/A	14510	 <b>NEW</b>
1685	Sill Flap/Insert - 300m Roll	Roll	N/A	16169	
1990	Sill Plug - Black Bag of 80 (60 plugs & 20 slotted)	Bag	N/A	16109	
1672	Interlock Cushion - 100m Roll To Suit SD106	Roll	N/A	16169	
1601	Bulb Seal Co-Extruded	Roll	N/A	16169	
1720	Weatherstrip 69-525 Black - 450m Roll	Roll	5	16173	
1721	Weatherstrip 69-525 Black with Fin - 400m Roll	Roll	5	16173	



## ANTHONY INNOVATIONS ARCHITECTURAL SLIDING DOOR HARDWARE

CODE	DESCRIPTION	U.O.M.	BOX QTY.	GROUP ID	
1800	Anthony Innovations 9017NA Roller for Single Wheel Sliding Door - 40kg	Each	100	16149	
1801	Anthony Innovations 9017DNA Roller for Dual Wheel Sliding Door - 80kg	Each	100	16149	
1802	Anthony Innovations TraXtar Duo, high performance - 110kg	Each	50	16149	 <b>NEW</b>
1808	Anthony Innovations Quad Roller - 150kg	Each	20	16149	
1803	Fixed Panel Adjustment Block	Each	100	16149	

# ARCHITECTURAL SLIDING DOOR HARDWARE

	CODE	DESCRIPTION	U.O.M.	BOX QTY.	GROUP ID
	1805	Filler Block to Suit Apartment Door <i>**Specify finish: Black-BL, Gray-GR, White-WH.</i>	 Pair	10	16149
	1806	Anti Lift Block to Suit Apartment Door <i>**Specify finish: Black-BL, Gray-GR, White-WH.</i>	 Pair	10	16149
	1828	Flush Sill Interlock Block	Each	N/A	16169
	1673	90mm PVC Buffer Stop	Each	N/A	16169
	1673-150	150mm Buffer Stop	Each	N/A	16169
	1819	Apartment Door Sill Brace 150mm Fits SD602		20	16153
	1818	Apartment Door Twin Track Sill Brace 100mm Fits SD402		20	16153
	1807	End Caps for Apartment Door Threshold (High Performance). Suits SD159/160	Bag	10 Pairs	16109
	1694	End Caps Heavy Duty for Apartment Door Threshold. Suits SD159/160	Bag	10 Pairs	16149
	1904	Apartment Door Corner Entry Female Stile Block For SD164	Bag	10 Pairs	16149
	2642	Foam Seal - Slide in 500m Roll (Everton)	Roll	N/A	16177
	1678	Rubber Interlock Block Suits SD137/151	Each	N/A	16149
	1679	Rubber Interlock Block Suits SD139/152	Each	N/A	16149
	1478	Foam Seal - 455 Sets Roll. Suits SD401/402	Roll	N/A	16177
	1477	Foam Seal - 995 Pieces Roll. Suits SD602	Roll	N/A	16177
	1476	Foam Seal - 905 Pieces Roll. Suits SD601	Roll	N/A	16177
	1912	Setting Block/Fixed Panel Spacing Block. Bag of 500	Bag	500	16157
	1834	Hole Plug 10mm. Bag of 200	Bag	N/A	16109
	1058	Door Stopper - Black	Each	N/A	16121
	1598	End Cap Threshold. Suits SD603	Bag	N/A	16109
	TJ404L	Sump Sill End Cap. Fits with TJ400 Finish - M/F, CL/ANOD	Each	N/A	16157
	TJ404R	Sump Sill End Cap. Fits with TJ400 Finish - M/F, CL/ANOD	Each	N/A	16157
	TJ604L	Sump Sill End Cap. Fits with TJ600 Finish - M/F, CL/ANOD	Each	N/A	16157
	TJ604R	Sump Sill End Cap. Fits with TJ600 Finish - M/F, CL/ANOD	Each	N/A	16157

 Please check with your local branch for stock availability.

# ARCHITECTURAL SLIDING DOOR HARDWARE



## LOCKWOOD ARCHITECTURAL SLIDING DOOR HARDWARE

CODE	DESCRIPTION	U.O.M.	BOX QTY.	GROUP ID
1252-**	ONYX Lock - D Inner/Slim Outer, 5 Pin Cyl - K/D, Surface Strike <i>**Specify finish: Black-BL, Silver-SCA</i>	Each	10	16149
1352-**	ONYX Lock - D Inner/Slim Outer, 5 Pin Cyl - K/N J031, Surface Strike <i>**Specify finish: Black-BL, Silver-SCA</i>	Each	10	16149
1253	ONYX Lock-D Inner/Slim Outer, 5 Pin Cyl - K/D, Surface Strike Satin Chrome	Each	10	16149
1254-**	ONYX Lock - Slim Inner/Slim Outer, 5 Pin Cyl- K/D, Surface Strike <i>**Specify finish: Black-BL, Silver-SCA</i>	Each	10	16149
1354-**	ONYX Lock - Slim Inner/Slim Outer, 5 Pin Cyl- K/N J031, Surface Strike <i>**Specify finish: Black-BL, Silver-SCA</i>	Each	10	16149
1255	ONYX Lock - Slim Inner/Slim Outer, 5 Pin Cyl- K/D, Surface Strike Satin Chrome	Each	10	16149
1256	ONYX Extra Wide Strike - Black	Each	10	16149
1257	ONYX Extra Wide 25mm Strike - Satin Chrome	Each	10	16149
1260-BL	ONYX Lock Handle Packer - Black	Each	10	16149
1260-SCA	ONYX Lock Handle Packer - Silver	Each	10	16149
1261	ONYX Lock Handle Packer - Satin Chrome	Each	10	16149



# ARCHITECTURAL SLIDING DOOR HARDWARE



## AUSTRAL YARRA LOCKS & CYLINDERS

	CODE	DESCRIPTION	U.O.M.	BOX QTY.	GROUP ID
	1358-BL	Yarra View Ridge Sliding Glass Door Deadlock - Black	Each	N/A	16149
	1258-**	Yarra View Edge Sliding Door Lock Need 2 Cylinders 1268 or 1269 to go with Lock <i>**Specify finish: Black-BL, Silver-SCA</i>	Each	5	16149
	1268	C4 5 Pin Cylinder Yarra View - K/Alike - Single Cylinder Only, Key No Is 249	Bag	10	16149
	1269	C4 5 Pin Cylinder Yarra View - K/Differ - Single Cylinder Only	Bag	10	16149
	1269-KAP	C4 5 Pin Cylinder Yarra View- K/Alike In Pairs for Double Cylinders Lock	Bag	5	16149
	1258-SCA-25	Yarra View Edge Sliding Door Lock with 25mm Striker Plate	Each	N/A	16149
	1258-BLK-25	Yarra View Edge Sliding Door Lock with 25mm Striker Plate	Each	N/A	16149
	1168	Striker Plate - Adjustable	Each	N/A	16149
	1262-BLS	Yarra Single Beak Sliding Patio Lock Single Cylinder 16mm Catch Black	Each	N/A	16149
	1263-BLS	Yarra Single Beak Sliding Patio Lock Single Cylinder 25mm Catch Black	Each	N/A	16149
	1262-BLD	Yarra Single Beak Sliding Patio Lock Double Cylinder 16mm Catch Black	Each	N/A	16149
	1263-BLD	Yarra Single Beak Sliding Patio Lock Double Cylinder 25mm Catch Black	Each	N/A	16149
	1264	4mm Handle Packer for Yarra Essential	Each	N/A	16149

 Please check with your local branch for stock availability.

CityView™ • Arch. Sliding Door System

# ARCHITECTURAL SLIDING DOOR HARDWARE





## ALLEGION VERTA RANGE

CODE	DESCRIPTION	U.O.M.	BOX QTY.	GROUP ID	
1012	Verta Offset Pull Handle <i>**Specify finish: Black-BL, Stainless Steel-SS.</i>	Each Set	N/A	16129	 <b>NEW</b>
1013	Verta 800mm Inline Pull Handle <i>**Specify finish: Black-BL, Stainless Steel-SS.</i>	Each Set	N/A	16129	 <b>NEW</b>
1014	Verta Euro Cylinder Escutcheon <i>**Specify finish: Black-BL, Stainless Steel-SS.</i>	Each	N/A	16129	 <b>NEW</b>
1113	Sliding Mortice Lock 28.5mm Backset Suits 1145 - 1149 Cylinders	Each	N/A	16129	 <b>NEW</b>
1114	Sliding Mortice Lock 40mm Backset No Cylinder Suits 1145 - 1149 Cylinders	Each	N/A	16129	 <b>NEW</b>
1015	Verta Flush Pull <i>**Specify finish: Black-BL, Stainless Steel-SS.</i>	Each	N/A	16129	 <b>NEW</b>

TO BE  
DISCONTINUED









## LOCKWOOD SELECTOR LOCKS

CODE	DESCRIPTION	U.O.M.	BOX QTY.	GROUP ID	
1145	Euro Cylinder - 5 Pin/60mm Keyed to Differ Suits with 1141 Lock	Each	10	16129	
1146	Economy Euro Cylinder - 5 Pin/60mm Keyed Alike. Suits 1141 Lock	Each	10	16129	
1149	Euro Cylinder - 5 Pin/Turn Keyed Alike Suits 1141 Lock	Each	10	16129	

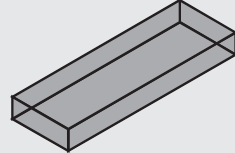
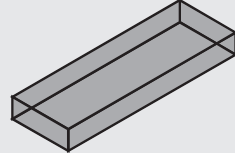

# ARCHITECTURAL SLIDING DOOR HARDWARE

**CODE DESCRIPTION U.O.M. BOX QTY. GROUP ID**

CODE	DESCRIPTION	U.O.M.	BOX QTY.	GROUP ID	
1900-M	Frame Packers - 1.5mm X 90mm . Blue 100/Bag	Bag	N/A	16157	
1901-M	Frame Packers - 3mm X 90mm . Green 100/Bag	Bag	N/A	16157	
1902-M	Frame Packers - 5mm X 90mm. Ochre 100/Bag	Bag	N/A	16157	
1903-M	Frame Packers - 10mm X 90mm . Black 100/Bag	Bag	N/A	16157	
1906	Aluminium Frame Packers 1mm 100/Bag	Bag	N/A	6149	
1907	Aluminium Frame Packers 2mm 100/Bag	Bag	N/A	6149	
1908	Aluminium Frame Packers 5mm 100/Bag	Bag	N/A	6149	
1909	Aluminium Frame Packers 10mm 100/Bag	Bag	N/A	6149	
1910	Setting Blocks 3mm Thick - Bag of 1,000	Bag	N/A	16157	
1911	Setting Blocks 5mm Thick - Bag of 1,000	Bag	N/A	16157	
1912	Setting Blocks 10mm Thick - Bag of 500	Bag	N/A	16157	
1977	Setting Blocks 5mm X 25mm - 3m Self Adhesive	Bag	N/A	17320	
1978	Setting Blocks 10mm X 25mm - 3m Self Adhesive	Bag	N/A	17320	
1979	Setting Blocks 3mm X 10mm X 25mm - 3m Double Sided Tape - Bag of 200	Bag	N/A	17320	
1930	End Cap To Suit Subsills - Bag of 50 Pairs (L&R)	Bag	N/A	16157	
1960	Lanotec General Purpose Liquid Lanolin 400g	Tube	12	16181	
1961	Lanotec "Citra Force" Cleaner Degreaser 400g	Tube	12	16181	
DTL2000	101.6mm Apartment Door Press Suits SD105/106/109/137/139/141	Each	N/A	16149	

CityView™ • Arch. Sliding Door System



As bushfires continue to pose significant threat to homes and properties in fire-prone areas of Australia, here at Darley Aluminium we remain committed to delivering products which meet demanding building regulations for buildings in these areas.

Darley Aluminium's window and door systems are configurable to offer a wide range of protection levels to bushfires, all without compromising on the functionality, performance, aesthetics or value you can expect from a Darley Aluminium product.



*For further information including compliance levels & fabrication details, please contact your nearest Darley Aluminium Office or visit our websites.*

# Bushfire Attack Level (BAL40)

Darley Aluminium Systems

## DOOR SECTIONS

35MM DOOR		
GLASS THICKNESS	WEDGE REQUIRED	POCKET SIZE
6mm	1612	9.6mm

45MM STANDARD DOOR - SG 45MM OPEN POCKET DOOR - SG		
GLASS THICKNESS	WEDGE REQUIRED	POCKET SIZE
6mm	1620 - 1620	14.5mm
8mm	1625 - 1625 OR 1620 - 1630	
10mm	1630 - 1630	

45MM OPEN POCKET DOOR - DG		
GLASS THICKNESS	WEDGE REQUIRED	POCKET SIZE
20mm	1933 - 1933 OR 1615 - 1623	33.2mm
22mm	1615 - 1933 OR 1620 - 1623 OR 1623 - 1684	
24mm	1615 - 1615 OR 1615 - 1684	
26mm	1620 - 1620 OR 1625 - 1684	
28mm	1625 - 1625	

45MM FLUSH FACE DOOR (WATER RATED)		
GLASS THICKNESS	WEDGE REQUIRED	POCKET SIZE
6mm	1620 - 1620 OR 1620 - 1684	14.5mm
8mm	1625 - 1625 OR 1630 - 1684	
10mm	1630 - 1630	
20mm	1623 - 1623	35.1mm
22mm	1933 - 1933	
24mm	1615 - 1623	
26mm	1615 - 1615 OR 1615 - 1684	
28mm	1620 - 1620 OR 1620 - 1684	

45MM DOUBLE BEADED DOOR - SG 45MM DOUBLE BEADED DOOR - DG			
GLASS THICKNESS	WEDGE REQUIRED	SPECIFIC PROFILES REQUIRED	POCKET SIZE
6mm	1630 - 1623	TJ202 bead	16.75mm
8mm	1620 - 1620		
10mm	1625 - 1625		
12mm	1630 - 1630		
24mm	1615 - 1615	TJ227 bead	35.1mm
26mm	1615 - 1933		
28mm	1620 - 1620		









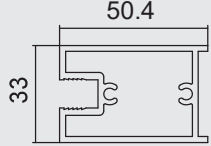

35mm Door

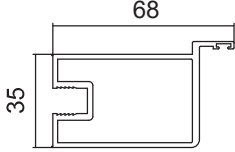

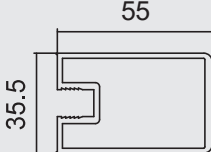
45mm Door

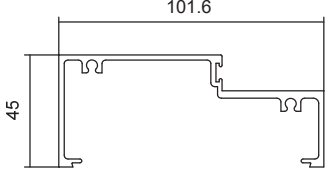
# 35MM DOOR SECTIONS

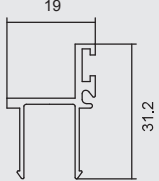







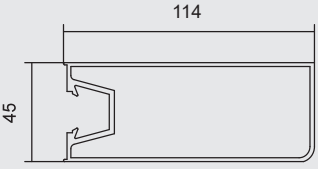

CODE	DESCRIPTION	LGTH.	FINISH	GROUP ID	
TJ380	Top & Bottom Rail Fits with TJ381/382  1612	6.5m	M/F CL/ANOD	9301 9302	
TJ381	Meeting Stile Fits with TJ380/382  1612,1710	6.5m	M/F CL/ANOD	9301 9302	
TJ382	Hinge & Lock Stile Fits with TJ380/381  1612	6.5m	M/F CL/ANOD	9301 9302	
TJ334	35mm Door Threshold Fits with TJ301/300/390/380/381/382  1720	6.5m	M/F CL/ANOD	9301 9302	
TJ335	35mm Door Stop Fits with TJ301/304/308/320/364/333/ TJ300/390/360  1720	6.5m	M/F CL/ANOD BZ/ANOD	9701 9702 9701	

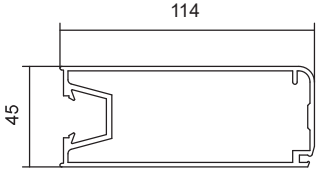

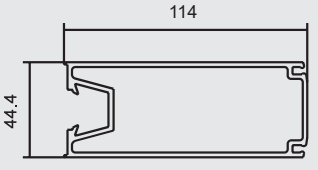
 Key hardware.

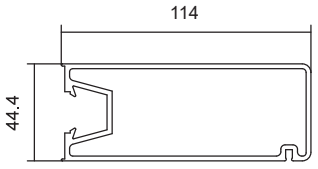
# 45MM DOOR SECTIONS

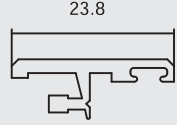
## STANDARD

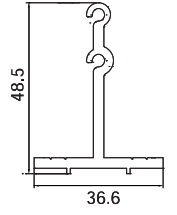









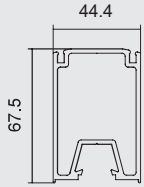

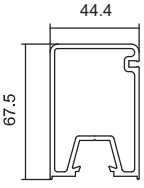
	CODE	DESCRIPTION	LGTH.	FINISH	GROUP ID
	TJ154	114mm Hinge Stile Fits with TJ313/315  1816, 1829	6.5m	M/F CL/ANOD	9401 9402
	TJ155	114mm Lock Stile Fits with TJ313/315  1816, 1829, 2590, 2600, 2610, 2620	6.5m	M/F CL/ANOD	9401 9402
	TJ158	114mm Pivot Stile Fits with TJ313/315  1816, 1829, 2590, 2600, 2610, 2620	6.5m	M/F CL/ANOD	9401 9402
	TJ159	114mm Sliding Stile Fits with TJ313/315  1816, 1829, 2590, 2600, 2610, 2620	6.5m	M/F CL/ANOD	9401 9402
	TJ332	Door Cover Fits with TJ312/321/155/158/412/ TJ440/450/HV312  1710	6.5m	M/F CL/ANOD	9701 9402
	TJ212	Mid Rail Bracket Fits with TJ124 / 369	4.0m	M/F	9401

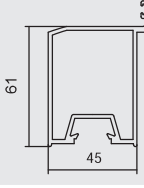

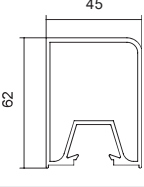
 Key hardware.

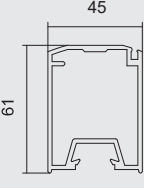
# 45MM DOOR SECTIONS

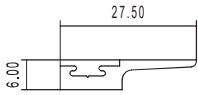
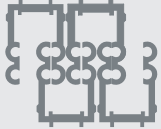

## STANDARD

CODE	DESCRIPTION	LGTH.	FINISH	GROUP ID	
TJ321	Pivot Door Stile Fits with TJ313/315  1816, 1829, 2590, 2600, 2610, 2620	6.5m	M/F CL/ANOD BZ/ANOD	9401 9402 9401	
TJ322	Sliding Door Stile Fits with TJ313/315  1816, 1829, 2590, 2600, 2610, 2620	6.5m	M/F CL/ANOD BZ/ANOD	9401 9402 9401	
TJ327	Meeting Stile Fits with TJ313/315  1816, 1829, 1705, 1710, 1714, 1715	6.5m	M/F CL/ANOD BZ/ANOD	9401 9402 9401	
TJ311	Hinge Stile Fits with TJ313/315  1816, 1829	6.5m	M/F CL/ANOD BZ/ANOD	9401 9402 9401	
		2.8m	M/F CL/ANOD	9401 9402	
TJ312	Lock Stile Fits with TJ313/315  1816, 1829, 2590, 2600, 2610, 2620	6.5m	M/F CL/ANOD BZ/ANOD	9401 9402 9401	
		2.8m	M/F CL/ANOD	9401 9402	
TJ341	Plant on Interlock  1720, 1721	6.5m	M/F CL/ANOD	9400 9400	
1816	Spigots for Commercial Doors Set of 4 with Bolts	Set	M/F	16169	
1829	Spigot Saddle Fits with 1816 - Optional	Set	M/F	16153	 

 Key hardware.

# 45MM DOOR SECTIONS

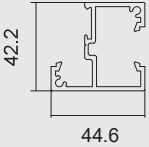
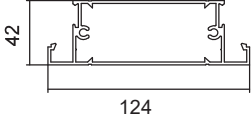
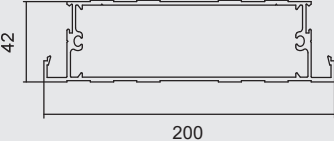
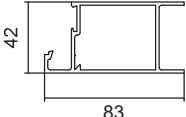

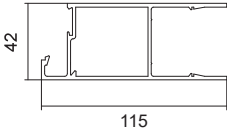
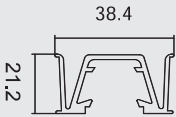



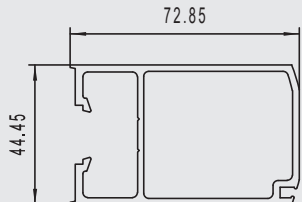

## STANDARD

	CODE	DESCRIPTION	LGTH.	FINISH	GROUP ID
	TJ326	45mm Mid Rail Fits with TJ311/312/314/321/322/327/ TJ154/155/158/159	6.5m	M/F CL/ANOD BZ/ANOD	9401 9402 9401
	TJ124	124mm Mid Rail Fits with TJ311/312/314/321/322/327/ TJ154/155/158/159	6.5m	M/F CL/ANOD BZ/ANOD	9401 9402 9401
	TJ369	200mm Mid Rail Fits with TJ311/312/314/321/322/327/ TJ154/155/158/159	6.5m	M/F CL/ANOD	9401 9402
	TJ313	Door Top Rail Fits with TJ311/312/314/321/322/327/ TJ154/155/158/159	6.5m	M/F CL/ANOD BZ/ANOD	9401 9402 9401
	TJ314	Door Bead Fits with TJ124/313/315/326/369	6.5m	M/F CL/ANOD BZ/ANOD	9401 9402 9401
	TJ315	Door Bottom Rail Fits with TJ311/312/314/321/322/327/ TJ154/155/158/159	6.5m	M/F CL/ANOD BZ/ANOD	9401 9402 9401
	TJ316	Mid Rail Adaptor Fits with TJ315	6.5m	M/F CL/ANOD	9401 9402

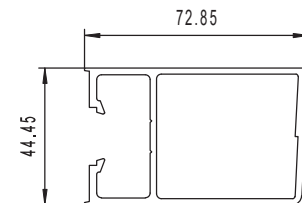
Darley Aluminium • Door Sections

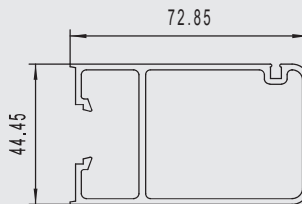
# 45MM DOOR SECTIONS

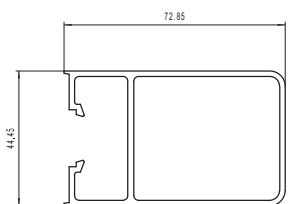
## OPEN POCKET

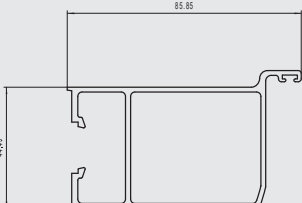
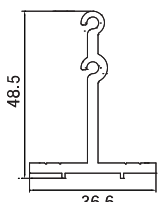
CODE	DESCRIPTION	LGTH.	FINISH	GROUP ID	
TJ440	73mm Open Pocket Lock Stile Fits with TJ313/315/332  1817, 1829, 2590, 2600, 2610, 2620	6.5m	M/F CL/ANOD	9401 9402	
TJ441	73mm Open Pocket Hinge Stile Fits with TJ313/315  1817, 1829	6.5m	M/F CL/ANOD	9401 9402	
TJ442	73mm Open Pocket Sliding Stile Fits with TJ313/315  1817, 1829, 2590, 2600, 2610, 2620	6.5m	M/F CL/ANOD	9401 9402	
TJ443	73mm Open Pocket Plain Stile Fits with TJ313/315/332  1817, 1829	6.5m	M/F CL/ANOD	9401 9402	
TJ444	73mm Open Pocket Meeting Stile Fits with TJ313/315  1710, 1817, 1829	6.5m	M/F CL/ANOD	9401 9402	
TJ212	Mid Rail Bracket Fits with TJ124/369	4m	M/F	9401	









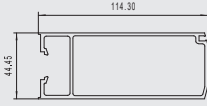

 Key hardware.

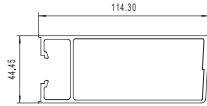

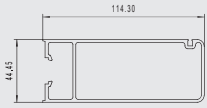

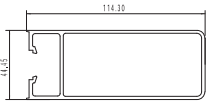
# 45MM DOOR SECTIONS

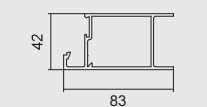
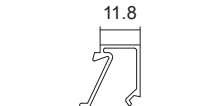
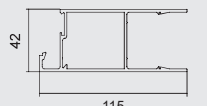
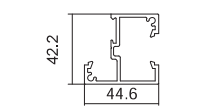
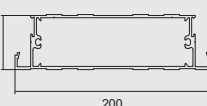
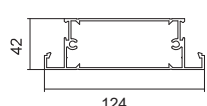
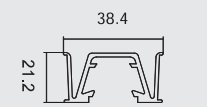
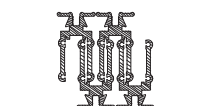









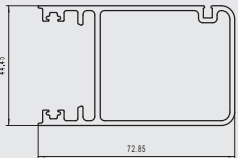

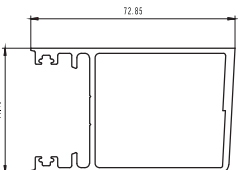
## OPEN POCKET

	CODE	DESCRIPTION	LGTH.	FINISH	GROUP ID
	TJ450	114mm Open Pocket Lock Stile Fits with TJ313/315/332  1817, 1829, 2590, 2600, 2610, 2620	6.5m	M/F CL/ANOD	9401 9402
	TJ451	114mm Open Pocket Hinge Stile Fits with TJ313/315  1817, 1829	6.5m	M/F CL/ANOD	9401 9402
	TJ452	114mm Open Pocket Sliding Stile Fits with TJ313/315  1817, 1829, 2590, 2600, 2610, 2620	6.5m	M/F CL/ANOD	9401 9402
	TJ453	114mm Open Pocket Plain Stile Fits with TJ313/315  1817, 1829	6.5m	M/F CL/ANOD	9401 9402
	TJ313	Door Top Rail Fits with TJ440/441/442/443/444/450/ TJ451/452	6.5m	M/F CL/ANOD	9401 9402
	TJ314	Door Bead Fits with TJ313/315	6.5m	M/F CL/ANOD	9401 9402
	TJ315	Door Bottom Rail Fits with TJ440/441/442/443/444/450/ TJ451/452	6.5m	M/F CL/ANOD	9401 9402
	TJ326	45mm Mid Rail Fits with TJ311/312/314/321/322/327/ TJ154/155/158/159	6.5m	M/F CL/ANOD BZ/ANOD	9401 9402 9401
	TJ369	200mm Mid Rail Fits with TJ311/312/314/321/322/327/ TJ154/155/158/159	6.5m	M/F CL/ANOD	9401 9402
	TJ124	124mm Mid Rail Fits with TJ311/312/314/321/322/327/ TJ154/155/158/159	6.5m	M/F CL/ANOD BZ/ANOD	9401 9402 9401
	TJ316	Mid Rail Adaptor Fits with TJ315	6.5m	M/F CL/ANOD	9401 9402
	1817	Open Pocket Spigot (Single Glazed & Double Glazed) Set of 4 with Bolts	Set	M/F	16169
	1829	Spigot Saddle Fits with 1817 - Optional	Set	M/F	16153

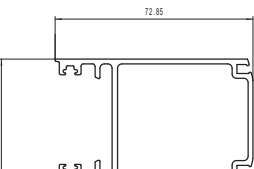
 Key hardware.

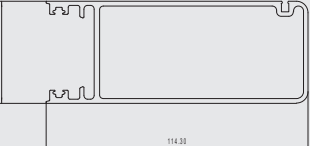
# 45MM DOOR SECTIONS

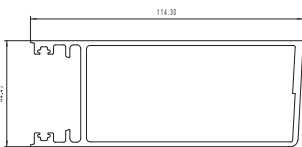

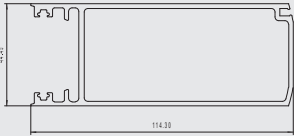



## OPEN POCKET - DOUBLE GLAZED

CODE	DESCRIPTION	LGTH.	FINISH	GROUP ID	
TJ416	73mm Open Pocket Sliding Stile Fits with TJ419/420  1817, 1829, 2590, 2600, 2610, 2620	6.5m	M/F CL/ANOD	9401 9402	
TJ417	73mm Open Pocket Hinge Stile Fits with TJ419/420  1817, 1829	6.5m	M/F CL/ANOD	9401 9402	
TJ418	73mm Open Pocket Lock Stile Fits with TJ419/420  1817, 1829, 2590, 2600, 2610, 2620	6.5m	M/F CL/ANOD	9401 9402	
TJ421	73mm Open Pocket Pivot Stile Fits with TJ419/420  1817, 1829, 2590, 2600, 2610, 2620	6.5m	M/F CL/ANOD	9401 9402	
TJ428	114mm Open Pocket Sliding Stile Fits with TJ419/42  1817, 1829, 2590, 2600, 2610, 2620	6.5m	M/F CL/ANOD	9401 9402	
TJ435	114mm Open Pocket Hinge Stile Fits with TJ419/420  1817, 1829	6.5m	M/F CL/ANOD	9401 9402	
TJ436	114mm Open Pocket Lock Stile Fits with TJ419/420  1817, 1829, 2590, 2600, 2610, 2620	6.5m	M/F CL/ANOD	9401 9402	

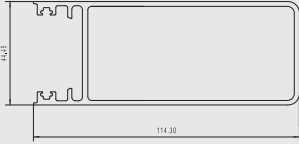
 Key hardware.

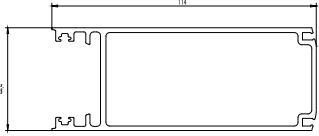
# 45MM DOOR SECTIONS

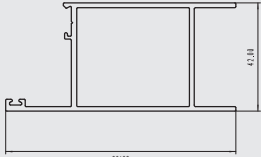
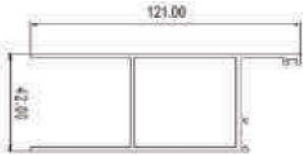
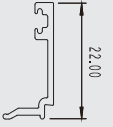
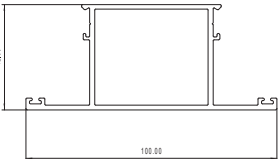
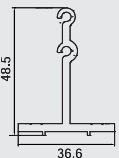
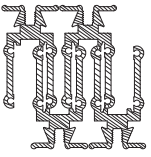









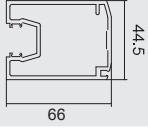

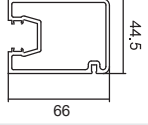

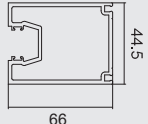
## OPEN POCKET - DOUBLE GLAZED

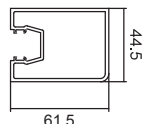
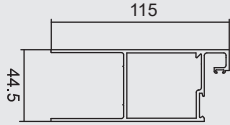
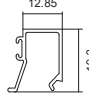
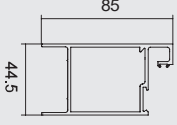
	CODE	DESCRIPTION	LGTH.	FINISH	GROUP ID
	TJ437	114mm Open Pocket Plain Stile Fits with TJ419/420/438  1817, 1829	6.5m	M/F CL/ANOD	9401 9402
	TJ439	114mm Open Pocket Pivot Stile Fits with TJ419/420  1817, 1829	6.5m	M/F CL/ANOD	9401 9402
	TJ419	Double Glazed Top Rail Fits with TJ227	6.5m	M/F CL/ANOD	9401 9402
	TJ420	Double Glazed Bottom Rail Fits with TJ227	6.5m	M/F CL/ANOD	9401 9402
	TJ227	Double Glazed Bead Fits with TJ419/420/438	6.5m	M/F CL/ANOD	9401 9402
	TJ438	Double Glazed 100mm MidRail Fits with TJ227	6.5m	M/F CL/ANOD	9401 9402
	TJ212	Mid Rail Bracket Fits with TJ438	4m	M/F	9401
	1817	Open Pocket Spigot (Single Glazed & Double Glazed) Set of 4 with Bolts	Set	N/A	16169
	1829	Spigot Saddle Fits with 1817 - Optional	Set	M/F	16153

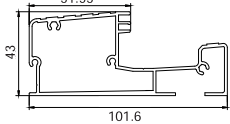
 Key hardware.

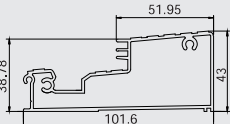
# 45MM DOOR SECTIONS

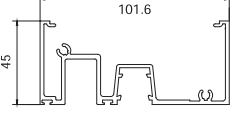
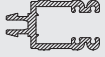

## FLUSH FACE

CODE	DESCRIPTION	LGTH.	FINISH	GROUP ID	
HV312	Lock Stile  1825, 1829, 2590, 2600, 2610, 2620	6.5m	M/F CL/ANOD	10501 10502	
HV322	Sliding Door Stile  1825, 1829, 2590, 2600, 2610, 2620	6.5m	M/F CL/ANOD	10501 10502	
HV271	Door Stile  1682, 1825, 1829, 2590, 2600, 2610, 2620	6.5m	M/F CL/ANOD	10501 10502	
		2.8m	M/F CL/ANOD	10501 10502	
HV272	Hinge Stile  1825, 1829	6.5m	M/F CL/ANOD BZ/ANOD	10501 10502 10501	
HV273	Large Rail Fits with HV274	6.5m	M/F CL/ANOD	10501 10502	
HV274	Door Bead Fits with HV273/289	6.5m	M/F CL/ANOD	10501 10502	
HV289	Small Rail Fits with HV274	6.5m	M/F CL/ANOD	10501 10502	
TJ348	Water-rated Sill Inward  1683, 1926	6.5m	M/F CL/ANOD	8301 8302	 
TJ349	Water-rated Sill Outward  1683, 1926	6.5m	M/F CL/ANOD	8301 8302	 
TJ346	Water-rated Head (Inward & Outward) Fits with HV031  1754	6.5m	M/F	17310	
1825	Spigots for Multifold Door Set of 4 includes Bolts Suits HV271/272/273/281/289	Set	N/A	16101	
1829	Spigot Saddle Fits with 1825 - Optional	Set	M/F	16153	 

 Key hardware.

# 45MM DOOR SECTIONS



## DOUBLE BEADED DOOR

	CODE	DESCRIPTION	LGTH.	FINISH	GROUP ID
	TJ200	Pivot Stile Fits with TJ202/227  1820, 2590, 2600, 2610, 2620	6.5m	M/F CL/ANOD	9501 9502
	TJ201	Hinge Stile/Plain Fits with TJ202/227  1820	6.5m	M/F CL/ANOD	9501 9502
	TJ204	Sliding Stile Fits with TJ202/227  1820, 2590, 2600, 2610, 2620	6.5m	M/F CL/ANOD	9501 9502
	TJ211	Multifold Door Stile Fits with TJ202/227  1682, 2590, 2600, 2610, 2620	6.5m	M/F CL/ANOD	9501 9502
	TJ220	Multifold Door Stile Fits with TJ202/227  1820, 2590, 2600, 2610, 2620	6.5m	M/F CL/ANOD	9501 9502
	TJ202	Door Bead Fits with TJ200/201/204/210/211/226	6.5m	M/F CL/ANOD	9501 9502





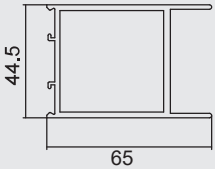
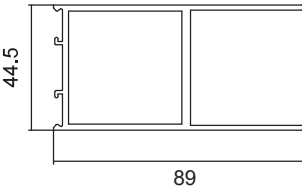
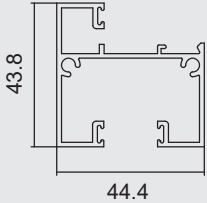
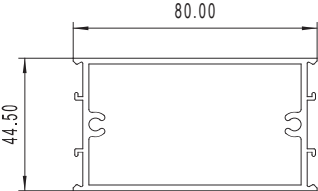
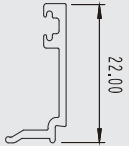
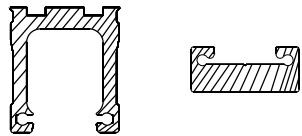
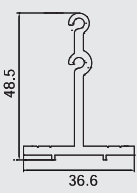



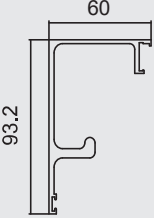

 Key hardware.

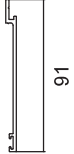
# 45MM DOOR SECTIONS

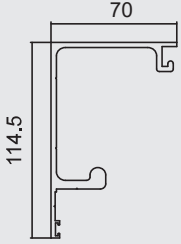
## DOUBLE BEADED DOOR

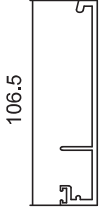
CODE	DESCRIPTION	LGTH.	FINISH	GROUP ID	
TJ207	Top Rail Fits with TJ202/227	6.5m	M/F CL/ANOD	9501 9502	
TJ203	Bottom Rail Fits with TJ202/227	6.5m	M/F CL/ANOD	9501 9502	
TJ226	45mm Mid Rail Fits with TJ202	6.5m	M/F CL/ANOD	9501 9502	
TJ209	80mm Mid Rail Fits with TJ202/227	6.5m	M/F CL/ANOD	9501 9502	
TJ227	Double Glazed Bead Fits with TJ200/201/203/204/207/208/ TJ209/211/220	6.5m	M/F CL/ANOD	9501 9502	
1820	Spigots For TJ200 Stiles Set of 4 with Bolts	Set	N/A	16153	
TJ212	Mid Rail Bracket Fits with TJ209	4m	M/F	9401	 

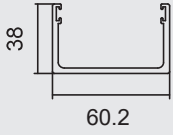
# COMMERCIAL DOOR TRACKS

	CODE	DESCRIPTION	LGTH.	FINISH	GROUP ID
	TJ323	Top Hung Door Track Fits with TJ324 Uses Roller 1810  1054, 1720, 1810	6.5m	M/F CL/ANOD BZ/ANOD	9601 9602 9601
	TJ324	Top Hung Door Track Cover Fits with TJ323  1720	6.5m	M/F CL/ANOD BZ/ANOD	9601 9602 9601
	TJ365	Heavy Duty Top Hung Door Track Fits with TJ366 Uses Roller 1809  1054, 1720, 1809	6.5m	M/F CL/ANOD	9601 9602
	TJ366	Heavy Duty Top Hung Door Track Cover Fits with TJ365  1720	6.5m	M/F CL/ANOD	9601 9602
	TJ325	Door Guide / Receiver Fits with TJ323/365  1720	6.5m	M/F CL/ANOD BZ/ANOD	9601 9602 9601



 Key hardware.

# COMMERCIAL DOOR TRACKS

CODE	DESCRIPTION	LGTH.	FINISH	GROUP ID	
TJ361	Stacking Door Track  1811	6.5m	M/F CL/ANOD	9601 9602	
TJ343	Top Hung Stacking Door Track  1813, 1814, 1815, 2590	6.5m	M/F CL/ANOD	9601 9602	
CH3218	Channel 25 x 25 x 3mm  1815	6.5m	M/F CL/ANOD	10301 10302	
TJ328	Door Guide / Receiver  1720	6.5m	M/F CL/ANOD	10301 10302	
TJ329	Door Guide / Cover Fits with TJ328	6.5m	M/F CL/ANOD	9401 9402	
TJ374	Pip Track	6.5m	M/F CL/ANOD	9401 9402	
LV052	50mm Louvre Door Insert for LV050	6.0m	M/F CL/ANOD	22801	
LV050	50mm Louvre Blade	6.0m	M/F CL/ANOD	22801	

 Key hardware.



# DOOR SECTION HARDWARE

	CODE	DESCRIPTION	U.O.M.	BOX QTY.	GROUP ID
	1001	Entrance Handle 300 x 32 Back to Back Straight SSS	Set	12	16113
	1002	Entrance Handle 300 x 32 Back to Back Offset SSS	Set	12	16113
	1003	Entrance Handle 300 x 32 Back to Back Curved SSS	Set	12	16113
	1004	Entrance Handle 178 x 19 Offset SSS	Each	50	16113
	1020**	Entrance Handle Elephant Ears 230mm Includes Bolts <i>**Specify finish: Black - BL, Bronze Anod - BA, Clear Anod - CA, Mill Finish - MF, Primrose - PR, White - WH.</i>	Pair	1	16113
	1056	Panic Bolt Visible Fix OffSet 300mm	Each	10	16121
	1057	Panic Bolt Visible Fix 300mm	Each	10	16121
	1059	Floor Mounted Door Stop - Satin Chrome	Each	50	16121
	1066-**	Flushbolt Standard - 300mm <i>**Specify finish: Black-BL, Satin Chrome-SC.</i>	Each	10	16121
	1067-**	Flush Bolt Standard - 600mm <i>**Specify finish: Satin Chrome-SC.</i>	Each	10	16121
	1066-ROD600	Flushbolt Extension Rod Only 600mm Suits 1066	Each	1	16201
	1066-ROD900	Flushbolt Extension Rod Only 900mm Suits 1066	Each	1	16201
	1055-FBB	Flushbolt Block Suits HV271 with Standard Flushbolt	Each	N/A	16101
	1068	Floor Ferule to Suit 1066/1067 Flushbolt Stainless Steel	Each	1	16121







Key hardware.



Please check with your local branch for stock availability.

# HINGES

**CODE DESCRIPTION U.O.M. BOX QTY. GROUP ID**

1030**	Hinge Wrap Around Type <i>**Specify finish: Black-BL, Clear Anod-CA.</i>	Each	6	16117	
1035	Heavy Duty Fast Fix Hinge	Each	N/A	16117	
1040	Hinge Fast Fix Stainless Steel ST3 For Aluminium to Aluminium	Each	100	16117	
1041	Hinge Fast Fix Stainless Steel ST9 For Timber Door to Aluminium	Each	100	16117	
1045	Hinge Fast Fix Aluminium ST3 CL/Anod Aluminium to Aluminium	Each	20	16117	

## Brio BRIO HINGES RANGE

**CODE DESCRIPTION U.O.M. BOX QTY. GROUP ID**

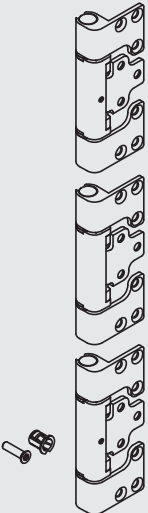
1046 - WH	Adjustable Hinge Set 50 Non-Morticed - White (powdercoat)	Set	N/A	16101	
1046 - SN	Adjustable Hinge Set 50 Non-Morticed - Satin Nickel	Set	N/A	16101	
1047 - SS	Adjustable Hinge Set 100 Non-Morticed - S/Steel	Set	N/A	16101	



Please check with your local branch for stock availability.

# DOOR CLOSERS



## YALE FIXED POWER DOOR CLOSER RANGE

CODE	DESCRIPTION	U.O.M.	BOX QTY.	GROUP ID
1069-3	Yale Size 3 Standard Arm Door Closer (60Kg Max) Silver - Door Pulls Open From Inside	Each	1	16125
1069-4	Yale Size 4 Standard Arm Door Closer (80Kg Max) Silver - Door Pulls Open From Inside	Each	1	16125
1069-5	Yale Size 5 Standard Arm Door Closer (100Kg Max) Silver - Door Pulls Open From Inside	Each	1	16125
1070-3	Yale Size 2 Parallel Arm Door Closer (40Kg Max) Silver - Door Pushes Open From Inside	Each	1	16125
1070-4	Yale Size 3 Parallel Arm Door Closer (60Kg Max) Silver - Door Pushes Open From Inside	Each	1	16125
1070-5	Yale Size 4 Parallel Arm Door Closer (80Kg Max) Silver - Door Pushes Open From Inside	Each	1	16125
1071-03	Yale Hold Open Arm Suits 1069 & 1071-01 Closers	Each	1	16125



## YALE POWER ADJUSTABLE DOOR CLOSER

1071-01	Yale Power Adjustable Door Closer Size Range 2-6	Each	1	16125
1071-02	Yale Slide Arm Assembly Suits 1071-01	Each	1	16125
1071-03	Yale Hold Open Arm Suits 1069- & 1071-01 Closers	Each	1	16125



Build-in Delayed Action and Back Check.  
Each Pack Contains "Z" Parallel Bracket.

Darley Aluminium • Door Sections

# DOOR CLOSERS



## LOCKWOOD OVERHEAD TRANSOM RANGE - FITS WITH TJ350 & TJ351

CODE	DESCRIPTION	U.O.M.	BOX QTY.	GROUP ID
1074-3	Lookwood Size 3, Non-Hold, Open Transom Closer	Each	1	16125
1074-4	Lookwood Size 4, Non-Hold, Open Transom Closer	Each	1	16125
1077-3	Lookwood Size 3, 90 Degree Hold, Open Transom Closer	Each	1	16125
1077-4	Lookwood Size 4, 90 Degree Hold, Open Transom Closer	Each	1	16125
1078-3	Lookwood Size 3, 105 Degree Hold, Open Transom Closer	Each	1	16125
1078-4	Lookwood Size 4, 105 Degree Hold, Open Transom Closer	Each	1	16125



\*\* Other Sizes Available On Request



## LOCKWOOD POWER ADJUSTABLE SURFACE MOUNTED

CODE	DESCRIPTION	U.O.M.	BOX QTY.	GROUP ID
1060	Lockwood 2000 Series Door Closer, Silver - Standard Arm (Power adj sizes 2, 3 and 4) - Parallel Arm (Power adj sizes 2 and 3)	Each	8	16125
1061	Lockwood 2000 Series Door Closer, Silver. - Standard Arm (Power adj sizes 2, 3 and 4) - Parallel Arm (Power adj sizes 2 and 3) - Back Check Included	Each	8	16125



## RYOBI RYOBI PARALLEL ARM + HOLD OPEN ARM CLOSER

CODE	DESCRIPTION	U.O.M.	BOX QTY.	GROUP ID
1085	Ryobi 163P Door Closer - Parallel + Hold Open Arms (60Kgs Max.)	Each	1	16125



## dormakaba DORMAKABA DOOR CLOSER

CODE	DESCRIPTION	U.O.M.	BOX QTY.	GROUP ID
1072-2	Dormakaba TS77 Standard Arm, Size 2 (40kg) Closer, Silver	Each	1	16125
1072-3	Dormakaba TS77 Standard Arm, Size 3 (60kg) Closer, Silver	Each	1	16125
1072-4	Dormakaba TS77 Standard Arm, Size 4 (80kg) Closer, Silver	Each	1	16125



NEW

# LOCKS - COMMERCIAL



## LOCKWOOD SHORT BACK SET, CYLINDERS & ACCESSORIES

	CODE	DESCRIPTION	U.O.M.	BOX QTY.	GROUP ID
 <p>23mm Backset</p> <p>Cylinder or Escutcheon Not Included</p>	1150	Lockwood 3540F Series Single Action Cylinder & Lever - 22mm Throw Bolt (No Cylinder or Escutcheon Included)	Each	10	16129
	1151	Lockwood 3541F Series Single Action Cylinder & Lever - 28mm Hook Throw Bolt - No Strike Box (No Cylinder or Escutcheon Included)	Each	10	16129
	1152	Lockwood 3542F Series Single Action Cylinder & Lever - 35mm Hook Throw Bolt - No Strike Box (No Cylinder or Escutcheon Included)	Each	10	16129
 <p>1166</p> <p>1150-ESC</p> <p>1126</p> <p>1127</p>	1166	Hook throw strike box suits 1151/1152	Each	10	16129
	1150-ESC	Lockwood 3540F Mortice Lock Escutcheon & Retaining Clip	Each	10	16129
	1126	Cylinder To Suit 3540 - Key To Differ	Each	10	16133
	1127	Cylinder To Suit 3540 - Key Alike	Each	10	16133



## YALE SHORT BACK SET, CYLINDERS & ACCESSORIES

	CODE	DESCRIPTION	U.O.M.	BOX QTY.	GROUP ID
 <p>23mm Backset</p>	1180	Short Backset Mortice Lock - 22mm Throw - Cylinder & Turn	Each	20	16129
	1181	Short Backset Mortice Lock - 22mm Throw - Double Cylinder	Each	20	16129
	1182	Short Backset Mortice Lock - 36mm Throw - Cylinder & Turn	Each	20	16129
	1183	Short Backset Mortice Lock - 36mm Throw - Double Cylinder	Each	20	16129
 <p>23mm Backset</p>	1184	Sliding Door Short Backset Mortice Lock - 29mm Hook Throw - Cylinder & Turn With Strike Box	Each	20	16129
	1185	Sliding Door Short Backset Mortice Lock - 29mm Hook Throw - Double Cylinder With Strike Box	Each	20	16129
	1188	Escape Lever	Each	N/A	16129





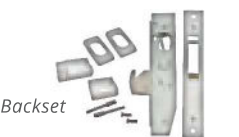







## DORMAKABA SHORT BACK SET, CYLINDERS & ACCESSORIES

	CODE	DESCRIPTION	U.O.M.	BOX QTY.	GROUP ID
 <p>NEW</p> <p>23mm Backset</p>	1194	Dormakaba 950 Lock Body 22mm bolt, incl. 2 Escutcheons and C4 Cylinders	Each	N/A	16129
	1195	Dormakaba 950 Lock Body 37mm bolt, incl. 2 Escutcheons and C4 Cylinders	Each	N/A	16129
	1197	Dormakaba 950 Lock Body 22mm bolt, incl. 2 Escutcheons, C4 Cyl. and C/F Turn	Each	N/A	16129
	1198	Dormakaba 950 Lock Body 37mm bolt, incl. 2 Escutcheons, C4 Cyl. and C/F Turn	Each	N/A	16129
 <p>NEW</p> <p>23mm Backset</p>	1196	Dormakaba 951 Lock Body 29mm Hook Bolt, incl. 2 Escutcheons and C4 Cylinders	Each	N/A	16129
	1199	Dormakaba 951 Lock Body 29mm Hook Bolt, incl. 2 Escutcheons, C4 Cyl. and C/F Turn	Each	N/A	16129

# LOCKS - COMMERCIAL

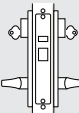
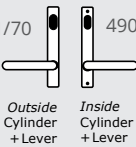
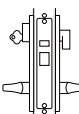
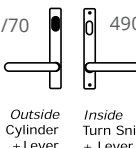
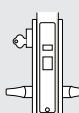
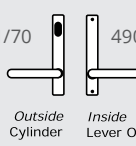
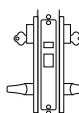
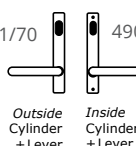
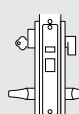
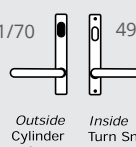

## LOCKWOOD SELECTOR MORTICE LOCKS & KITS, CYLINDERS

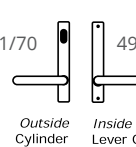

CODE	DESCRIPTION	U.O.M.	BOX QTY.	GROUP ID		
1140	Electric Strike 12 Volt	Each	N/A	16129		 <b>NEW</b>
1109	Extended Bi-Fold Striker	Each	N/A	16129		
1175	Lockwood Selector 3782SS Short Backset Mortice Lock. <i>No Cylinder Included</i>	Each	10	16129		
1103-ADP	Snib Adaptor Suit 1103 Furniture	Each	10	16133		
1176	Lockwood Selector 3782 Lock Kit 01 Double Cylinder Set - Includes: • 3782SS Mortice Lock • 4801/70SC Lever on External Plate with Cylinder Hole • 4901/70SC Lever on Internal Plate with Cylinder Hole • Double Cylinder • Accessory Packets To Suit	Set	10	16129	 23mm Backset	 4801/70 4901/70 Outside Cylinder + Lever Inside Cylinder + Lever
1177	Lockwood Selector 3782 Lock Kit 04 Cylinder And Turn Set - Includes: • 3782SS Mortice Lock • 4801/70SC Lever on External Plate with Cylinder Hole • 4904/70SC Lever on Internal Plate with Turnknob • Cylinder • Turnknob Adaptor • Accessory Packets to Suit	Set	10	16129	 23mm Backset	 4801/70 4904/70 Outside Cylinder + Lever Inside Turn Snib + Lever
1178	Lockwood Selector 3782 Lock Kit 05 Single Cylinder Set - Includes: • 3782SS Mortice Lock • 4801/70SC Lever on External Plate with Cylinder Hole • 4905/70SC Lever on Internal Plain Plate • Cylinder • Accessory Packets to Suit	Set	10	16129	 23mm Backset	 4801/70 4905/70 Outside Cylinder Inside Lever Only
1277	Lockwood Universal 5782 Lock Kit 01 Double Cylinder Set - Includes: • 5782SS Mortice Lock • 4801/70SC Lever on External Plate with Cylinder Hole • 4901/70SC Lever on Internal Plate with Cylinder Hole • Double Cylinder • Accessory Packets to Suit • 114mm Stile Only	Set	10	16129	 30mm Backset	 4801/70 4901/70 Outside Cylinder + Lever Inside Cylinder + Lever
1278	Lockwood Universal 5782 Lock Kit 04 Cylinder And Turn Set - Includes: • 5782SS Mortice Lock • 4801/70SC Lever on External Plate with Cylinder Hole • 4904/70SC Lever on Internal Plate with Turnknob • Cylinder • Turnknob Adaptor • Accessory Packets to Suit • 114mm Stile Only	Set	10	16129	 30mm Backset	 4801/70 4904/70 Outside Cylinder + Lever Inside Turn Snib + Lever
1279	Lockwood Universal 5782 Lock Kit 05 Single Cylinder Set - Includes: • 5782SS Mortice Lock • 4801/70SC Lever on External Plate with Cylinder Hole • 4905/70SC Lever on Internal Plain Plate • Cylinder • Accessory Packets to Suit • 114mm Stile Only	Set	10	16129	 30mm Backset	 4801/70 4905/70 Outside Cylinder Inside Lever Only

Darley Aluminium • Door Sections

# LOCKS - COMMERCIAL





## PLATE FURNITURE FOR LOCKWOOD SELECTOR LOCKS

	CODE	DESCRIPTION	U.O.M.	BOX QTY.	GROUP ID
	1101	Lockwood 4905/70 Internal Plate & Lever No Cylinder Hole - SCP	Each	10	16129
	1102	Lockwood 4901/70 Internal Plate & Lever With Cylinder Hole - SCP	Each	10	16129
	1103	Lockwood 4904/70 Internal Plate & Lever With Turn - SCP	Each	10	16129
	1104	Lockwood 4800 External Plate With Cylinder Hole - SCP	Each	10	16129
	1105	Lockwood 4801/70 External Plate & Lever With Cylinder Hole - SCP	Each	10	16129



## ALLEGION LEGGE LOCK KITS & CYLINDERS

	CODE	DESCRIPTION	U.O.M.	BOX QTY.	GROUP ID
 <p>23mm Backset</p>	9950S	995 V Series Vestibule Lock Office/Classroom Lock Kit Stainless Steel Single Cylinder	Each	Set	16129
	9951S	995 C Series Combination Entry Lock Kit Stainless Steel Cylinder & Turn Set	Each	Set	16129
	9952S	995 C Series Combination Lock Glass Door Lock Kit Stainless Steel Double Cylinder	Each	Set	16129
 <p>23mm Backset</p>	9953B	995 V Series Vestibule Lock Office/Classroom Lock Kit Black Single Cylinder	Each	Set	16129
	9954B	995 C Series Combination Entry Lock Kit Black Cylinder & Turn Set	Each	Set	16129
	9955B	995 C Series Combination Lock Glass Door Lock Kit Black Double Cylinder	Each	Set	16129





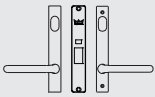
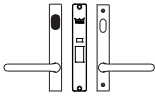
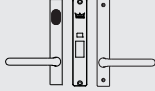

## DORMAKABA MORTICE LOCKS, KITS & CYLINDERS

	CODE	DESCRIPTION	U.O.M.	BOX QTY.	GROUP ID
	1191	Dormakaba SB2212 Lock Kit, Double Cylinder Entry Lock with 6400/6401/30 23mm Backset	Each	N/A	16129
	1192	Dormakaba SB2212 Office Lock Kit, Cylinder and Turn with 6400/6403/30 23mm Backset	Each	N/A	16129
	1193	Dormakaba SB2212 Classroom Lock Kit, External Cylinder with 6400/6406/30 23mm Backset	Each	N/A	16129

# LOCKS - COMMERCIAL

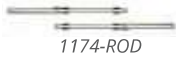

## ALLEGION SCHLAGE RANGE

CODE	DESCRIPTION	U.O.M.	BOX QTY.	GROUP ID		
1172	2P Lock Body 30mm Back Set with Strike Plate Suits 1145-1149 Cylinders	Each	N/A	16129		
1174	4P Lock Body 30mm Back Set with Strike Plate Suits 1145-1149 Cylinders	Each	N/A	16129		
1174-ROD	4P Lock Rod Set 3.5m D-Tip	Each	N/A	16129		



## ALLEGION VERTA RANGE

CODE	DESCRIPTION	U.O.M.	BOX QTY.	GROUP ID		
1011-INT	Verta Furniture Plate - Internal <i>**Specify finish: Black-BL, Satin Steel-SS.</i>	Each	N/A	16129		
1011-EXT	Verta Furniture Plate - External	Each	N/A	16129		
1012	Verta Offset Pull Handle <i>**Specify finish: Black-BL, Satin Steel-SS.</i>	Each Set	N/A	16129		
1013	Verta 800mm Inline Pull Handle <i>**Specify finish: Black-BL, Satin Steel-SS.</i>	Each Set	N/A	16129		
1014	Verta Euro Cylinder Escutcheon <i>**Specify finish: Black-BL, Satin Steel-SS.</i>	Each	N/A	16129		
1113	Sliding Mortice Lock 28.5mm Backset Suits 1145 - 1149 Cylinders	Each	N/A	16129		
1114	Sliding Mortice Lock 40mm Backset Suits 1145-1149 Cylinders	Each	N/A	16129		
1015	Verta Flush Pull <i>**Specify finish: Black-BL, Satin Steel-SS.</i>	Each	N/A	16129		

## Brio BRIO 288 DUAL POINT LOCK RANGE

CODE	DESCRIPTION	U.O.M.	BOX QTY.	GROUP ID	
15146-ZBL	Furniture Handle 85 Ctr, Zinc Black (PBK)	Each	N/A	16101	
15146-SN	Furniture Handle 85 Ctr, Satin Nickel (PVD CLR)	Each	N/A	16101	
15146-SSS	Furniture Handle 85 Ctr, Satin Stainless Steel	Each	N/A	16101	
15146-M-ZBL	Magnetic Furniture Handle 85 Ctr, Zinc Black (PBK)	Each	N/A	16101	
15146-M-SN	Magnetic Furniture Handle 85 Ctr, Satin Nickel (PVD)	Each	N/A	16101	
15146-BL-MAG	Magnetic/Rubb Leaf Catch Set, Black	Each	N/A	16101	
15146-SN-MAG	Magnetic/Rubb Leaf Catch Set, Satin Nickel	Each	N/A	16101	



# LOCKS - COMMERCIAL

	CODE	DESCRIPTION	U.O.M.	BOX QTY.	GROUP ID
	1141	Optimum 2 Point Lock Body Only - 30mm Backset - No Cylinder	Each	10	16129
	1147	Palladium Handle - Black Suits 1141 Lock	Set	10	16129
	1148	Palladium Handle - Satin Pearl Suits 1141 Lock	Set	10	16129
	1142	Palladium "Xtra" Handle Entrance Set - Black. To Fit with 1141	Each	10	16129
	1143	Palladium "Xtra" Handle Entrance Set - Satin Chrome. To Fit with 1141	Each	10	16129
	1153	Optimum / Palladium Kits - Black (1141 Lock & Striker, 1147) - No Cylinder	Set	10	16129
	1154	Optimum / Palladium Kits - Satin Chrome (1141 Lock & Striker, 1148) - No Cylinder	Set	10	16129
	1155	Sorrento Face Mount Single Point Lock - No Cylinder	Each	N/A	16129
	1156	Multi Point Accessory Pack Suits Sorrento 1155	Each	N/A	16129
	1157	Lazy Cam Cylinder 60mm Suits Sorrento 1155	Each	10	16129
	1159	Flush Tabs	Pair	N/A	16129
	1144	Euro Cylinder - 5 Pin/70mm. Keyed Alike Suits 1113/14/41/53/54/72/74	Each	10	16129
	1145	Euro Cylinder - 5 Pin/60mm. Keyed to Differ Suits 1113/14/41/53/54/72/74	Each	10	16129
	1146	Economy Euro Cylinder - 5 Pin/60mm Keyed Alike. Suits 1113/14/41/53/54/72/74	Each	10	16129
	1149	Euro Cylinder - 5 Pin/Turn. Keyed Alike Suits 1113/14/41/53/54/72/74	Each	10	16129
	1137	S/Steel Strike - Standard Suits 1141 Optimum Lock	Each	1	16129
	1138	S/Steel Extended Multifold Strike Suits 1141 Optimum Lock	Each	1	16101
	3000	Locking Bolt Guide (for Water Rated Door) - Bag of 10	Bag	N/A	17311

# DOOR SECTION HARDWARE

CODE	DESCRIPTION	U.O.M.	BOX QTY.	GROUP ID	
1810	Roller for Commercial Door Top Hung Max Weight 40kg To Suit TJ323	Pair	N/A	16149	
1809	Roller for Heavy Duty Commercial Door Top Hung. Max Weight 110kg To Suit TJ365	Each	N/A	16149	
1054	Top Track End Cap (Left / Right), Black To Suit TJ365	1 Pair	N/A	16149	
1811	Roller for Commercial Door Bottom Track Max Weight 50kg To Suit TJ361	Each	N/A	16149	
1824	Floor Guide Sliding Door	Each	N/A	16149	
1822	Roller Packer To Suit 1800, 1801, 1802, TJ203/313/420, HV273	Each	N/A	16149	
1813	Angle For Stacking Door Roller Fits with 1814/1815 to Suit TJ343	Each	N/A	16149	
1814	Roller for Stacking Door Track - 80KG Rated (Suit TJ343) Fits with 1813	Each	N/A	16149	
1815	Bottom Roller Guide Assembly Fits with 1813	Each	N/A	16149	
1816	Spigots for Commercial Doors Set of 4 with Bolts	Set	M/F	16169	
1817	Open Pocket Spigot (Single Glazed & Double Glazed) Set of 4 with Bolts	Set	N/A	16169	
1820	Spigots For TJ200 Stiles Set of 4 with Bolts	Set	N/A	16153	
1825	Spigots for Multifold Door Set of 4 includes Bolts Suits HV271/272/273/281/289	Set	N/A	16101	
1829	Spigot Saddle Fits 1816, 1817 or 1825 – Optional	Set	N/A	16153	 

# DOOR SECTION HARDWARE

	CODE	DESCRIPTION	U.O.M.	BOX QTY.	GROUP ID
	1900-M	Frame Packers - 1.5mm X 90mm Blue 100/Bag	Bag	N/A	16157
	1901-M	Frame Packers - 3mm X 90mm Green 100/Bag	Bag	N/A	16157
	1902-M	Frame Packers - 5mm X 90mm Ochre 100/Bag	Bag	N/A	16157
	1903-M	Frame Packers - 10mm X 90mm Black 100/Bag	Bag	N/A	16157
	1906	Aluminium Frame Packers 1mm 100/Bag	Bag	N/A	6149
	1907	Aluminium Frame Packers 2mm 100/Bag	Bag	N/A	6149
	1908	Aluminium Frame Packers 5mm 100/Bag	Bag	N/A	6149
	1909	Aluminium Frame Packers 10mm 100/Bag	Bag	N/A	6149
	1910	Setting Blocks 3mm Thick - Bag of 1,000	Bag	N/A	16157
	1911	Setting Blocks 5mm Thick - Bag of 1,000	Bag	N/A	16157
	1912	Setting Blocks 10mm Thick - Bag of 500	Bag	N/A	16157
	1977	Setting Blocks 5mm X 25mm - 3m Self Adhesive - Bag of 200	Bag	N/A	17320
	1978	Setting Blocks 10mm X 25mm - 3m Self Adhesive - Bag of 200	Bag	N/A	17320
	1979	Setting Blocks 3mm X 10mm X 25mm - 3m Double Sided Tape - Bag of 200	Bag	N/A	17320
	1930	End Cap To Suit Subsills Bag of 50 Pairs (Left & Right)	Bag	N/A	16157
	1960	Lanotec General Purpose Liquid Lanolin 400g	Tube	12	16181
	1961	Lanotec "Citra Force" Cleaner Degreaser 400g	Tube	12	16181



Please check with your local branch for stock availability.

# SYSTEM TOOLING

## CODE DESCRIPTION

DTL3109- 45mm Door Press  
AIR Suits TJ154/155/158/159/321/322/327/311/312/313/315/HV271/273/281/289



## FRINGE PILE

### CODE DESCRIPTION U.O.M. BOX QTY. GROUP ID

2590	Fringe Pile Weatherstrip Strip 11mm x 600m Roll - Black	Roll	N/A	6146
2600	Fringe Pile 13mm x 500m Roll - Black	Roll	N/A	6146
2610	Fringe Pile 16mm x 500m Roll - Black	Roll	N/A	6146
2620	Fringe Pile 28mm x 250m Roll - Black	Roll	N/A	6146
1705	Weatherstrip 48-525 Black - 500m Roll	Roll	N/A	16173
1710	Weatherstrip 48-425 Black - 550m Roll	Roll	N/A	16173
1720	Weatherstrip 69-525 Black - 450m Roll	Roll	N/A	16173
1611	Weatherstrip 90-900 Black - 150m Roll	Roll	N/A	16173



## RUBBERS / SEALS / FLAPS

### CODE DESCRIPTION U.O.M. BOX QTY. GROUP ID

1472	Water-rated Frame Gasket - 1050 Pieces Roll	Roll	1	16177
1610-M100	6mm Door Stop - 100m. Suits TJ306	Roll	1	16169
1612	Door Channel to Suit 6mm Glass Suits 35mm Door Sections (TJ380/381/382)	Roll	N/A	16169
1614	Door Stop Rubber - Large 200m	Roll	1	16169
1615	Glazing Wedge PVC - 200m Roll	Roll	1	16169
1620	Glazing Wedge PVC - 200m Roll	Roll	1	16169
1623	Glazing Wedge - 100m Roll	Roll	1	14510
1625	Glazing Wedge PVC - 250m Roll	Roll	1	16169
1630	Glazing Wedge PVC - 200m Roll	Roll	1	16169
1651	Glazing Wedge Captive Co-Extruded Santoprene - 100m Roll	Roll	N/A	16169
1684	Glazing Wedge Co-Extruded - 150m Roll	Roll	N/A	16169
1754	Foam Seal QL48100 - 250m	Roll	N/A	16169
1926	Drain Flap - 300m	Roll	N/A	16169
1933	Glazing Wedge - 125m Roll	Roll	N/A	16169

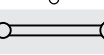

NEW



101.6mm LOUVRES



# MANUALLY OPERATED LOUVRE WINDOWS

## EASY LIVING

With louvres you can instantly adjust the amount of ventilation to suit your comfort. Enjoy refreshing breezes as well as keeping the elements out by incorporating our modern louvre system into your home.

- Beautiful
- Stylish
- Versatile

## TECHNICAL DETAILS

**Design Rating:** Up to 200pa for water  
Up to 3000pa wind pressure

**Retaining Clip:** UV resistant PP/PE incorporating glazing relief slot

**Handle 102mm (4"):** 304 Grade Laser-cut Stainless Steel,  
UV resistant PP/PE grip

**Handle 152mm (6"):** 304 Grade Laser-cut Stainless Steel,  
UV resistant PP/PE grip

**Louvre Channel:** 6063 Extruded Aluminium  
20mm x 38mm x 20mm (D x W x H)

## CREATIVE SOLUTIONS

Make louvre windows an architectural feature of your home.

- Choose from a variety of glass, aluminium or timber glazing options.
- Choose from 102mm (4") or 152mm (6") blade size.

**Operator:** Anodised aluminium control bar and stainless steel spin rivets

**Glazing:** 6mm Toughened and Float Glass  
6mm Extruded Aluminium Blade  
13.5mm\* Extruded Aluminium Blade  
13.5mm\* Timber Blade  
\* with adaptor

**Finishes:** Powder Coat - Black, White, White Birch  
Anodised - 25µm Natural anodised  
Special finishes available upon request

**Blade cutting formula:** = Daylight opening width - 59mm

## ADDITIONAL OPTIONS

At the time of order, the following can be ordered on request:

- Lock for louvre gallery (pre-installed by supplier) - BLACK, WHITE OR GREY
- Handles in non-standard positioning
- Concealed jamb/mullion clip cut to size with galleries
- Standard gallery joiner cut to size with gallery order
- Box gallery joiner cut to size with gallery order
- Gallery joiner fixing brackets
- Map rod head only
- Telescopic map rod (1.2 - 2.4m or 1.8 - 3.6m or 2.4 - 4.8m or 4.8 - 9.6m)
- Restricted Openings (Specify 70mm, 80mm, 100mm, 125mm)
- Oversized louvre galleries (taller than standard configurations)
- Dual control gallery (handle bar control adaptors included with louvre set)
- Non-standard manual handle type (low profile, low profile squared)
- Manual Winder (Crank)

### SPECIAL NOTE:

- Minimum order quantities may apply • Not all sizes / colours / configuration are available ex-stock • Supplier surcharge may apply.



# MANUALLY OPERATED LOUVRE WINDOWS

## 102MM LOUVRE GALLERY HEIGHT CHART

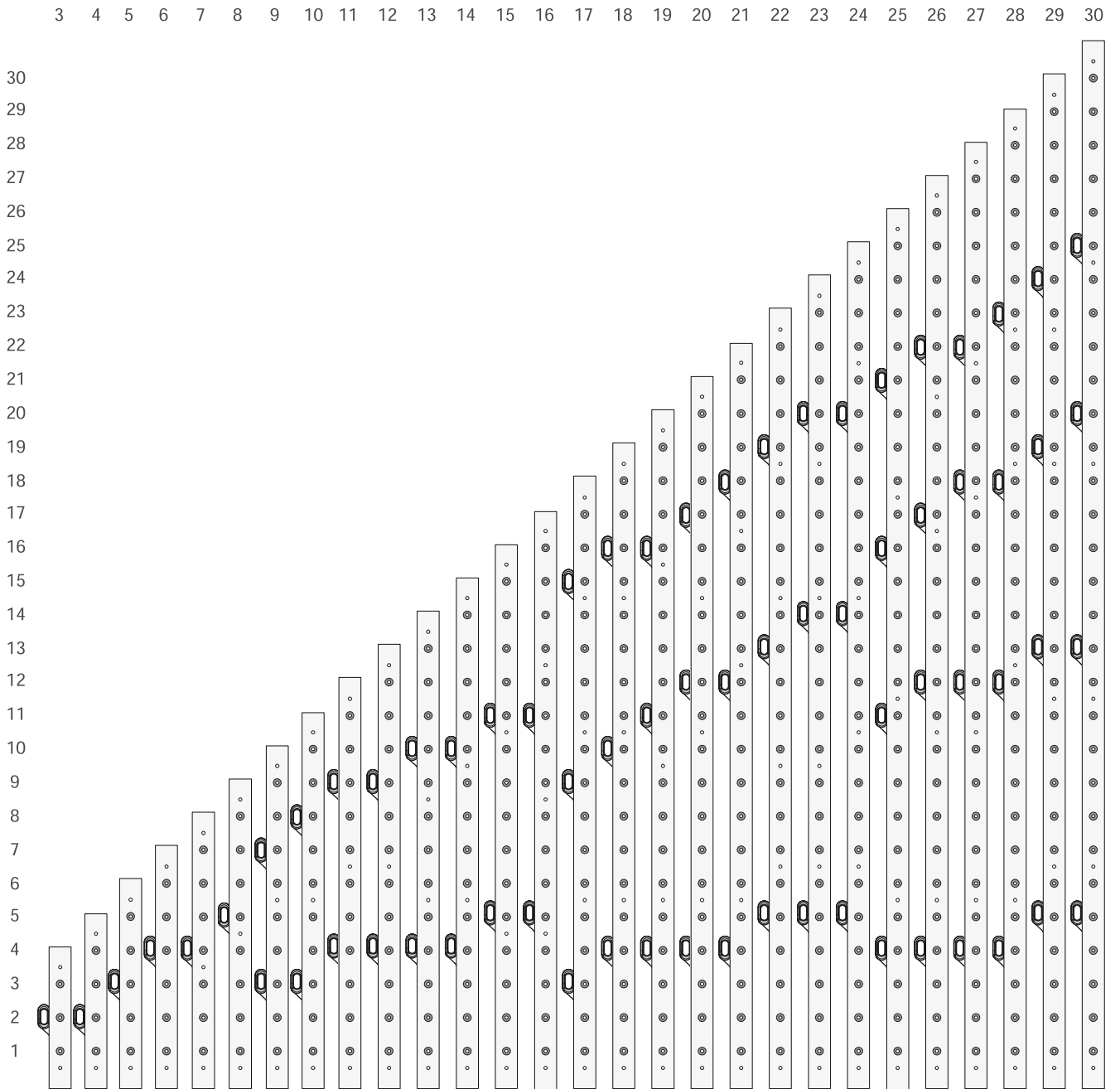

Height (mm)	3	4	5	6	7	8	9	10	11	12	13	14	15	16	17	18	19	20	21	22	23	24	25	26	27	28	29	30	
Height (mm)	292	381	470	559	648	737	826	915	1003	1092	1181	1270	1359	1448	1537	1626	1715	1803	1892	1981	2070	2159	2248	2337	2426	2515	2604	2693	
Head															5	6	6	6	7	7	7	8	6	6	6	7	7	7	
Sill	3	4	5	6	7	8	5	5	6	6	7	7	8	8	6	6	7	7	7	8	8	8	6	7	7	7	7	8	8

CityView™ • 101.6mm Louvre System

# MANUALLY OPERATED LOUVRE WINDOWS

## 102MM LOUVRE GALLERY HEIGHT CHART WITH FLOATING TOP CLIP

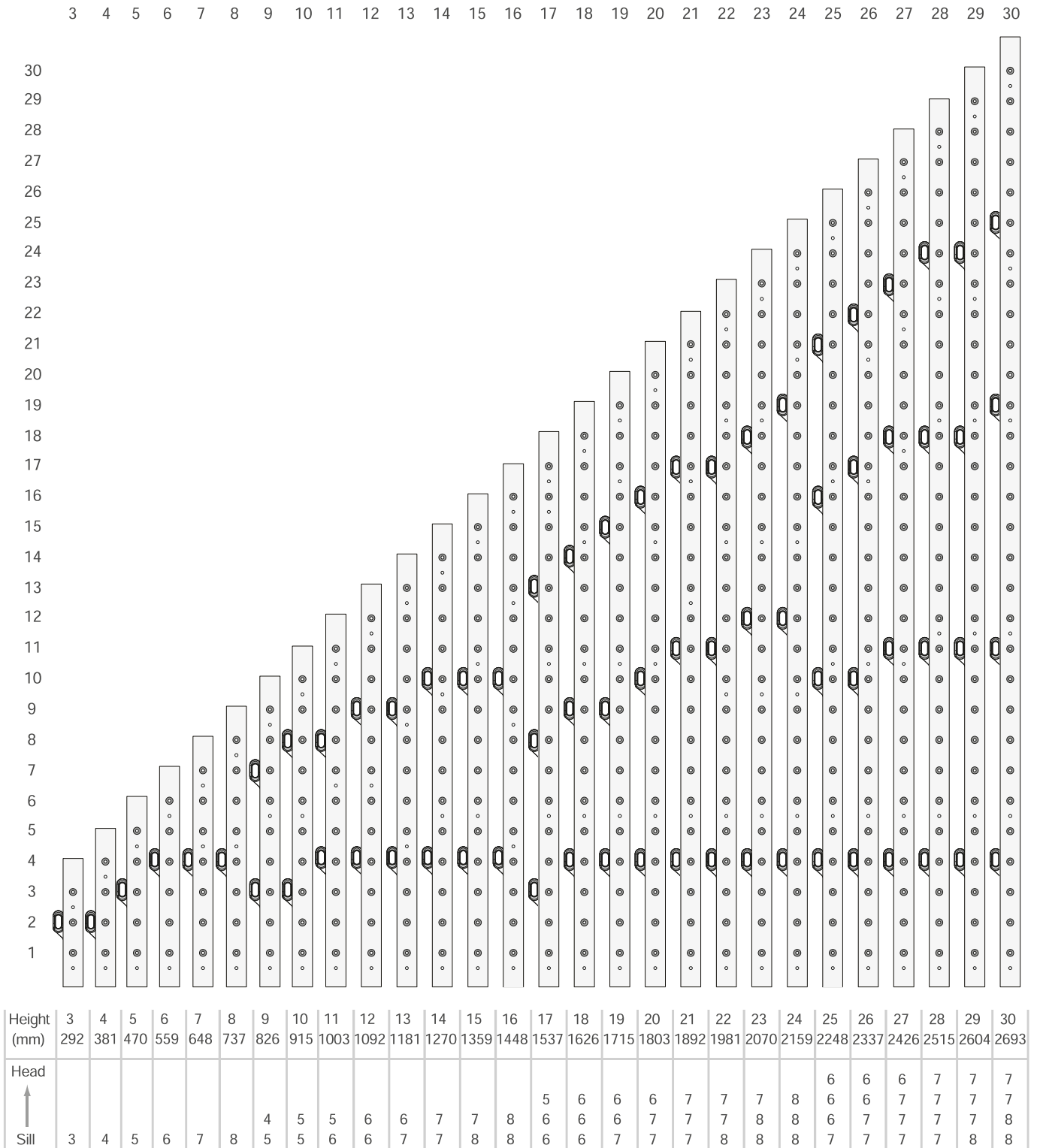

CityView™ • 101.6mm Louvre System



# MANUALLY OPERATED LOUVRE WINDOWS

## 152MM LOUVRE GALLERY HEIGHT CHART

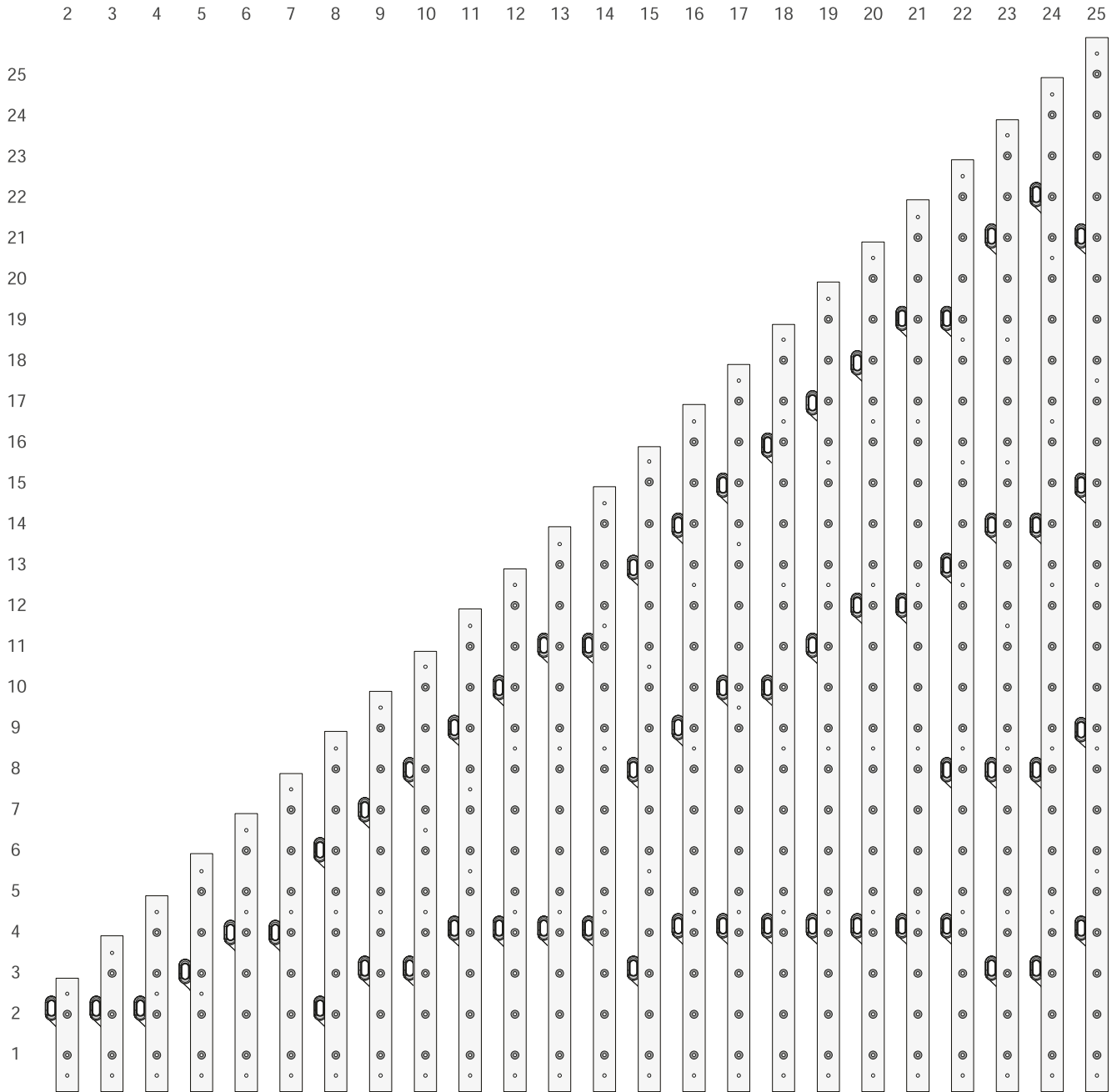

Height (mm)	305	445	585	724	864	1003	1143	1283	1422	1562	1702	1842	1981	2121	2261	2401	2540	2680	2820	2960	3099	3239	3378	3518	
Head														5	5	5	6	6	6	7	5	5	6	6	6
Sill	2	3	4	5	6	7	4	4	5	5	6	6	7	5	5	6	6	6	7	7	6	6	6	6	7

CityView™ • 101.6mm Louvre System

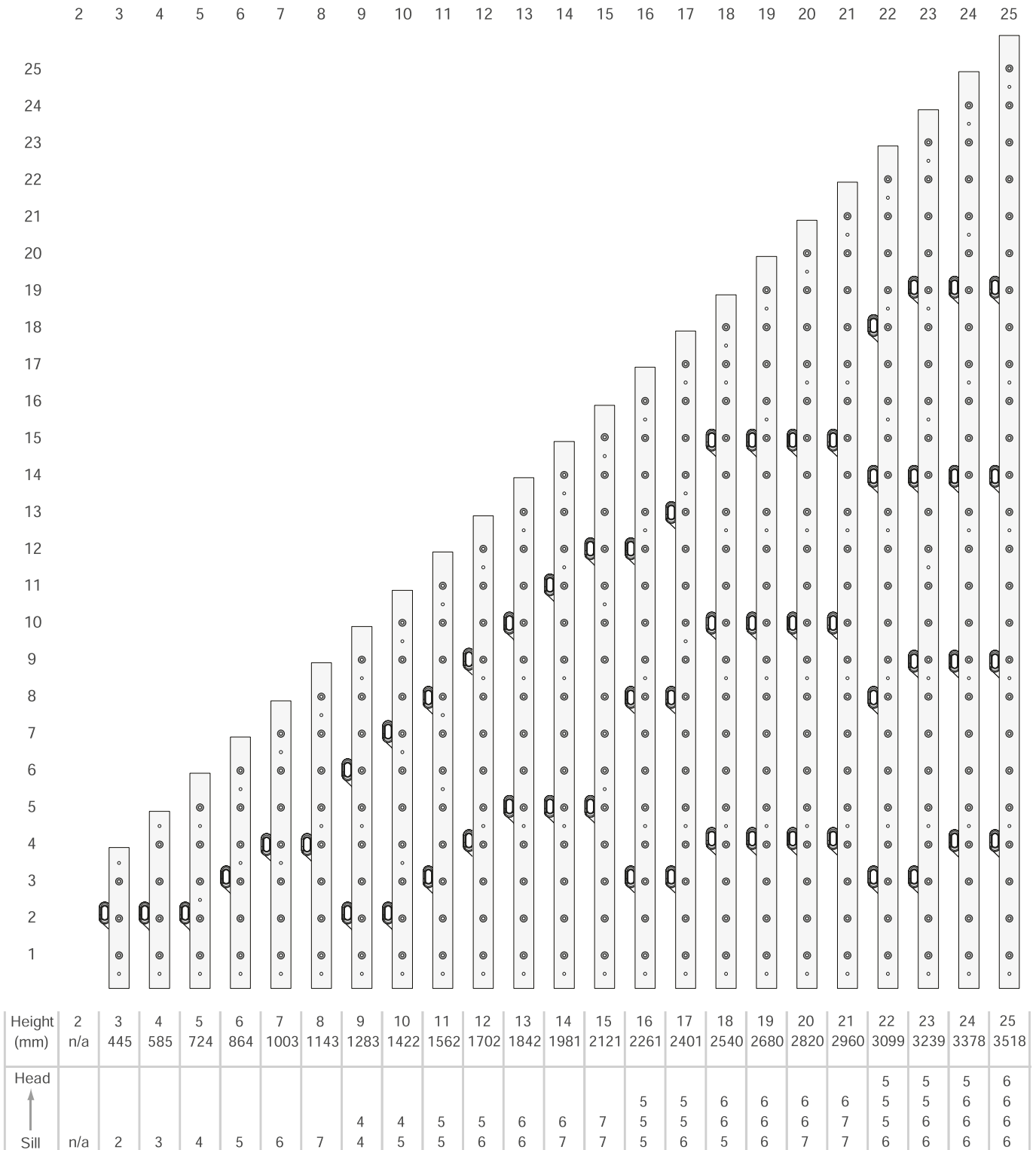

# MANUALLY OPERATED LOUVRE WINDOWS

## 152MM LOUVRE GALLERY HEIGHT CHART WITH FLOATING TOP CLIP







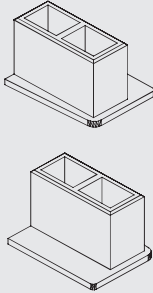

CityView™ • 101.6mm Louvre System

# MANUALLY OPERATED LOUVRE WINDOWS

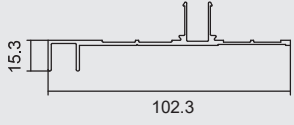

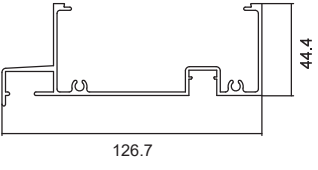

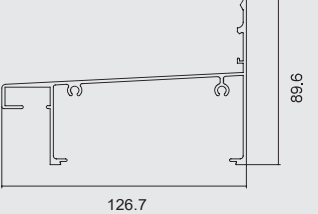
	PART NO.	DESCRIPTION	PER	SPECIAL COLOUR
	LV9-501	Co-Extruded Seal - 3.0m To Suit Louvre Weather Bars (Black, Grey, White)	Each	N/A
	LV9-527	Louvre Press Lock	Each	N/A
	LV9-1834	Head and Sill Infill Block For Cityview Frame	20 per bag	Black

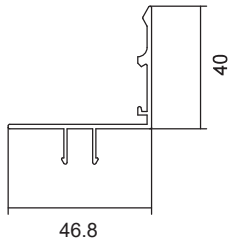
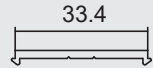
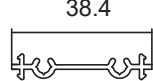
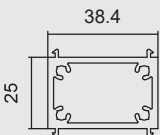

# CITYVIEW 101.6MM LOUVRE SYSTEM

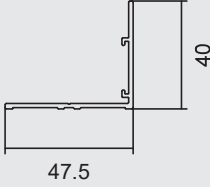
CODE	DESCRIPTION	LGTH.	FINISH	GROUP ID	
LVC001	Jamb Fits with TJ301	6.5m	M/F CL/ANOD	22301 22302	
LVC002	101.6mm Louvre Frame Head  1486  LV9-1834	6.5m	M/F CL/ANOD	22301 22302	
LVC003	101.6mm Louvre Frame Sill  1487  LV9-501, LV9-1834	6.5m	M/F CL/ANOD	22301 22302	
LVC005	Head Weather Bar Fits with LVC002  LV9-501	6.5m	M/F CL/ANOD	22301 22302	
LVC006	Jamb - Gallery Adaptor Fits with LCV001	3.0m	M/F	22301	
LVJ001	Gallery Joiner Back to Back	6.5m	M/F CL/ANOD	22301 22302	
LVJ002	Box Gallery Joiner Back to Back	6.5m	M/F CL/ANOD	22301 22302	

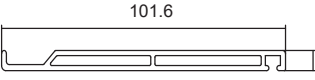
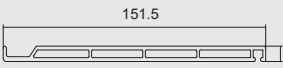
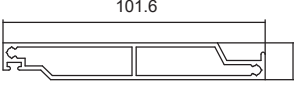
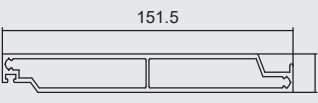
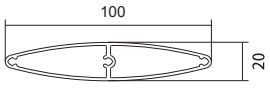
# CITYVIEW 101.6MM LOUVRE SYSTEM

	CODE	DESCRIPTION	LGTH.	FINISH	GROUP ID
	LVB040	40mm Weather Bar  LV9-501	3.0m	M/F CL/ANOD	22301 22302
			6.5m	M/F CL/ANOD	22301 22302
	LVB1026	102 x 6mm Blade	3.2m	M/F CL/ANOD	22301 22302
			3.65m (QLD)	M/F CL/ANOD	22301 22302
	LVB1526	152 x 6mm Blade	3.2m	M/F CL/ANOD	22301 22302
			3.65m (QLD)	M/F CL/ANOD	22301 22302
	LVB1013	102 x 13.5mm Blade	3.2m	M/F CL/ANOD	22301 22302
	LVB1513	152 x 13.5mm Blade	3.2m	M/F CL/ANOD	22301 22302
	LVE100	Louvre 100 X 20 Recommended Max Span 1600mm  3100	6.5m 6.0m	M/F CL/ANOD	22901 22902
	3100	Oval End Cap To Suit LVE100 Fits into Louvre Gallery	60/ pack	BLACK GREY WHITE	16157

 Key hardware

CityView™ • 101.6mm Louvre System

SPECIAL  
FEATURE

dormakaba 

Dormakaba offers innovative solutions for building & door openings, security and access control for a wide range of industries. Trusted by builders, fabricators, architects and designers, Dormakaba has a reputation for product reliability and impeccable customer service. Check out some of their latest products below or speak to your Account Manager about other products.



## SB2212 SERIES MORTICE LOCK KITS

- 23mm backset
- 316 stainless steel latch, dead latching bolt, face plate and striker plate as standard
- Nickel plated zinc alloy case
- Anti-lockout function as standard, that can easily be engaged or disengaged
- 316 stainless steel furniture as standard in kits
- Includes cylinders

### DARLEY CODE ITEM DESCRIPTION

1191	SB2212 Lock Kit - Double Cylinder Entry Lock with 23mm Backset
1192	SB2212 Office Lock Kit - Cylinder and Turn with 23mm Backset
1193	SB2212 Classroom Lock Kit - External Cylinder with 23mm Backset



## 950/951 SERIES SHORT BACKSET MORTICE DEADLOCKS

- Suits narrow stile door sections with 28mm internal thickness and 58mm external thickness
- 23mm backset
- Standard Kaba 130 type oval cylinder with M616 cam
- 22mm, 28mm & 37mm projection bolt

### DARLEY CODE ITEM DESCRIPTION

1194	Dormakaba 950 Lock Body 22mm Bolt, incl 2 Escutcheons and C4 Cylinders
1195	Dormakaba 950 Lock Body 37mm Bolt, incl 2 Escutcheons and C4 Cylinders
1196	Dormakaba 951 Lock Body 29mm Hook Bolt, incl 2 Escutcheons and C4 Cylinders
1197	Dormakaba 950 Lock Body 22mm Bolt, incl 2 Escutcheons, C4 Cyl and C/F Turn
1198	Dormakaba 950 Lock Body 37mm Bolt, incl 2 Escutcheons, C4 Cyl and C/F Turn
1199	Dormakaba 951 Lock Body 29mm Hook Bolt, incl 2 Escutcheons, C4 Cyl and C/F Turn



## TS77 DOOR CLOSER

- TS77 door closer is very quick and easy to install
- Choice of three strengths
- Door widths up to 1100mm with backcheck function
- Outstanding value for money
- Includes Parallel Arm Bracket as standard

### DARLEY CODE ITEM DESCRIPTION

1072-2	Dormakaba TS77 Standard Arm and Back Check Size 2 Closer (40kg) Silver
1072-3	Dormakaba TS77 Standard Arm and Back Check Size 3 Closer (60kg) Silver
1072-4	Dormakaba TS77 Standard Arm and Back Check Size 4 Closer (80kg) Silver

# RESIDENTIAL WINDOW & DOOR SYSTEMS



53mm & 76mm Sliding Window



53mm & 76mm Awning Window



53mm & 76mm Double Hung Window



53mm & 76mm Fixed Window



101.6mm Louvre Window



76mm French Door



101.6mm Sliding Door & 165mm Sliding Stacking Door

The Klassicview™ Range of Residential Windows and Doors is the ideal choice for modern architectural requirements, meeting current design trends as well as performance specifications.

The Klassicview™ range is suitable for residential and semi-commercial buildings.

The Klassicview™ range consists of the following:

- 53mm & 76mm Sliding Window
- 53mm & 76mm Awning Window
- 53mm & 76mm Double Hung Window
- 101.6mm Louvre Window
- 53mm & 76mm Fixed Window
- 101.6mm Sliding Door & 165mm Sliding Stacking Door
- 76mm French Door
- Plus a range of adaptors to create a range of window and door combinations



The Klassicview™ windows and doors have been fully tested and passed the stringent requirements of AS 2047.

The KlassicView range are not listed in this catalogue. Please contact our sales team if you are interested in becoming a licensed fabricator.



# KLASSICVIEW™ & HARBOURVIEW™ KITS

Darley now provides Kits to fabricators.

- Including aluminium, hardware and seals/gaskets
- Aluminium cut to size and punched
- Ready to assemble

Please contact our technical support or sales team for further information.

- Sliding Door
- 53mm sliding Window
- 53mm Awning Window
- 53mm Double Hung Window
- 53mm Fixed Light
- 76mm Sliding Window
- 76mm Awning Window
- 76mm Double Hung
- 76mm Fixed Light

To place an order go to

<http://darleyaluminium.com.au/products/order-online>

