

GEOMETRIC SECTIONS

Angles	321
Angles (Thickness = 1.6mm).....	321
Angles (Thickness = 3.0mm+).....	322
Flat Bars	323
Channels.....	324
Square Tubes	325
Rectangle Tubes	326
Round Tubes	327
Tee Sections	327

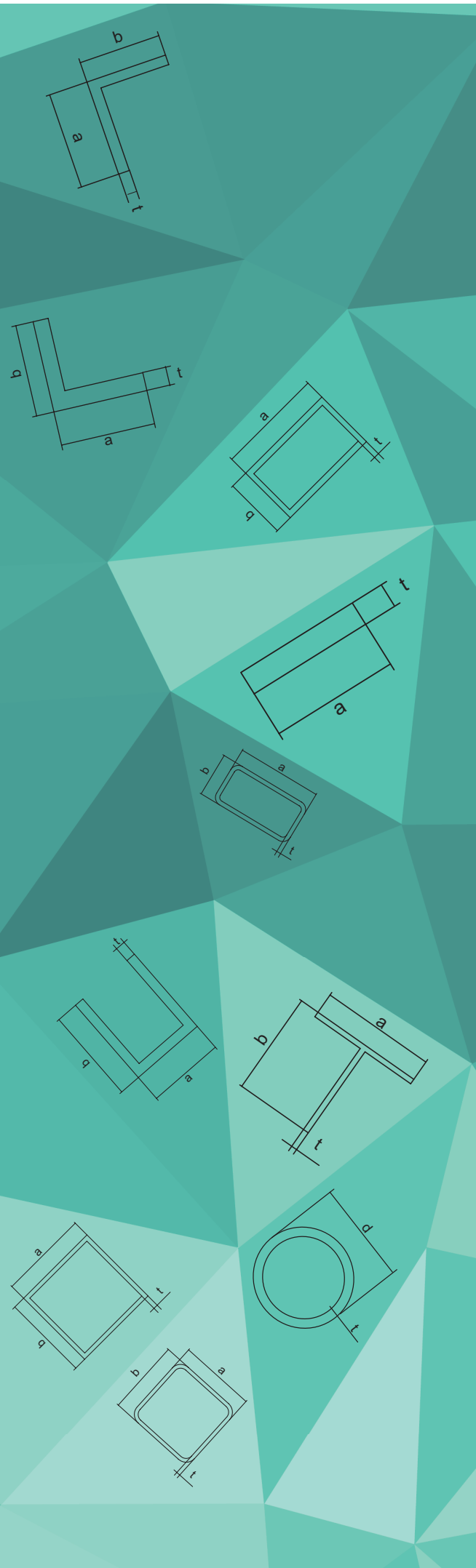

ANGLES

THICKNESS = 1.6 MM

CODE	SIZE (A*B*T)	LGTH	AP	FINISH	MASS	GROUP ID
AN1212	12 x 12 x 1.6mm	6.5m	48	M/F CL/ANOD	0.097	18101
AN1225	12 x 25 x 1.6mm	6.5m	74	M/F CL/ANOD	0.154	18101
AN1240	12 x 40 x 1.6mm	6.5m	104	M/F CL/ANOD	0.219	18101
AN2012	20 x 12 x 1.6mm	6.5m	64	M/F CL/ANOD	0.132	18101
AN2020	20 x 20 x 1.6mm	6.5m	100	M/F CL/ANOD	0.165	18101
AN2025	20 x 25 x 1.6mm	6.5m	100	M/F CL/ANOD	0.187	18101
AN2032	20 x 32 x 1.6mm	6.5m	104	M/F CL/ANOD	0.219	18101
AN2040	20 x 40 x 1.6mm	6.5m	120	M/F CL/ANOD	0.252	18101
AN2050	20 x 50 x 1.6mm	6.5m	140	M/F CL/ANOD	0.294	18101
AN2525	25 x 25 x 1.6mm	6.5m	100	M/F CL/ANOD	0.209	18101
AN2532	25 x 32 x 1.6mm	6.5m	114	M/F CL/ANOD	0.234	18101
AN2540	25 x 40 x 1.6mm	6.5m	130	M/F CL/ANOD	0.275	18101
AN2550	25 x 50 x 1.6mm	6.5m	150	M/F CL/ANOD	0.317	18101
AN2570	25 x 70 x 1.6mm	6.5m	190	M/F CL/ANOD	0.405	18101
AN4040	40 x 40 x 1.6mm	6.5m	160	M/F CL/ANOD	0.338	18101
AN4070	40 x 70 x 1.6mm	6.5m	220	M/F	0.440	18101
AN5050	50 x 50 x 1.6mm	6.5m	200	M/F CL/ANOD	0.425	18101

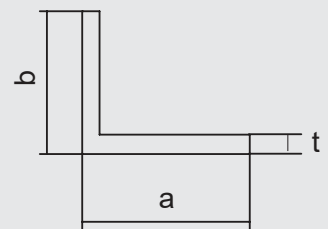

- Other powder-coated finishes may be available.
- Please check with your local branch for stock availability



ANGLES

THICKNESS = 3.0 MM +

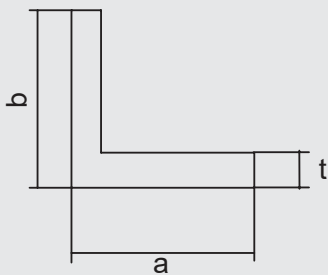

CODE	SIZE (A*B*T)	LGTH	AP	FINISH	MASS	GROUP ID
HAN2020	20 x 20 x 3.0mm	6.5m	100	M/F	0.300	18102
HAN2025	20 x 25 x 3.0mm	6.5m	100	M/F	0.341	18102
HAN2032*	20 x 32 x 3.0mm	6.5m	104	M/F	0.397	18102
HAN2040	20 x 40 x 3.0mm	6.5m	120	M/F	0.462	18102
HAN2080	20 x 80 x 3.0mm	6.5m	200	M/F	0.786	18102
HAN2525	25x 25 x 3.0mm	6.5m	100	M/F CL/ANOD	0.382	18102
HAN2540	25 x 40 x 3.0mm	6.5m	130	M/F	0.504	18102
HAN2550	25 x 50 x 3.0mm	6.5m	150	M/F	0.585	18102
HAN2570	25 x 70 x 3.0mm	6.5m	190	M/F	0.760	18102
HAN3232	32 x 32 x 3.0mm	6.5m	128	M/F	128.0	18102
HAN4006	40 x 40 x 6.0mm	6.5m	160	M/F	1.199	18102
HAN4040	40 x 40 x 3.0mm	6.5m	160	M/F	160.0	18102
HAN5050	50 x 50 x 3.0mm	6.5m	200	M/F CL/ANOD	1.210	18102
HAN7050	50 x 70 x 3.0mm	6.5m	240	M/F	0.950	18102
HAN50100*	50.8 x 101.6 x 3.0mm	6.5m	305	M/F	1.210	18102
HAN50125*	50 x 125 x 3.0mm	6.5m	350	M/F	1.393	18102
HAN50150	50 x 150 x 3.0mm	6.5m	400	M/F	1.595	18102
HAN5006	50 x 50 x 6.0mm	6.5m	200	M/F	1.527	18102
HAN8006*	80 x 80 x 6.0mm	6.5m	320	M/F	2.502	18102

- Available ex-Mill
- Please check with your local branch for stock availability



FLAT BARS

CODE	SIZE (A*T)	LGTH	AP	FINISH	MASS	GROUP ID
FB1225	12 x 2.5mm	4.0m	100	M/F, CL/ANOD	0.081	18201
FB1230	12 x 3.0mm	4.0m	100	M/F	0.097	18201
FB1260	12 x 6.0mm	4.0m	100	M/F	0.194	18201
FB1625	16 x 2.5mm	4.0m	100	M/F	0.108	18201
FB2030	20 x 3.0mm	4.0m	100	M/F, CL/ANOD	0.162	18201
FB2060	20 x 6.0mm	4.0m	100	M/F	0.324	18201
FB20100	20 x 10.0mm	4.0m	100	M/F	0.540	18201
FB2516	25 x 1.6mm	4.0m	100	M/F, CL/ANOD	0.109	18201
		2.8m	100	M/F, CL/ANOD	0.108	
FB2530	25 x 3.0mm	4.0m	100	M/F, CL/ANOD	0.203	18201
FB2560	25 x 6.0mm	4.0m	100	M/F, CL/ANOD	0.406	18201
FB3230	32 x 3.0mm	4.0m	100	M/F, CL/ANOD	0.260	18201
FB4016	40 x 1.6mm	4.0m	100	M/F, CL/ANOD	0.174	18201
FB4030	40 x 3.0mm	4.0m	86	M/F, CL/ANOD	0.325	18201
FB4060	40 x 6.0mm	4.0m	92	M/F, CL/ANOD	0.650	18201
FB40100	40 x 10.0mm	4.0m	100	M/F	1.080	18201
FB5030	50 x 3.0mm	4.0m	106	M/F, CL/ANOD	0.406	18201
FB5060	50 x 6.0mm	4.0m	112	M/F, CL/ANOD	0.812	18201
FB5080	50 x 8.0mm	4.0m	116	M/F, CL/ANOD	1.080	18201
FB50100	50 x 10.0mm	4.0m	120	M/F	0.350	18201
FB6030	60 x 3.0mm	4.0m	126	M/F, CL/ANOD	0.491	18201
FB8016	80 x 1.6mm	4.0m	163	M/F	0.346	18201
FB8030	80 x 3.0mm	4.0m	166	M/F, CL/ANOD	0.648	18201
FB80100	80 x 10.0mm	4.0m	180	M/F, CL/ANOD	2.160	18201
FB10016	100 x 1.6mm	3.6m	203	M/F, CL/ANOD	0.433	18201
FB10030	100 x 3.0mm	4.0m	206	M/F, CL/ANOD	0.812	18201
FB10060	100 x 6.0mm	4.0m	212	M/F	1.626	18201
FB100100	100 x 10.0mm	4.0m	220	M/F, CL/ANOD	2.700	18201
FB15016	150 x 1.6mm	2.8m	303	CL/ANOD	0.648	18201
FB15018	150 x 1.8mm	3.6m	304	M/F, CL/ANOD	0.729	18201

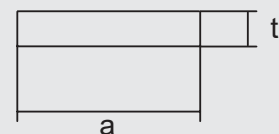

• Please check with your local branch for stock availability



CHANNELS

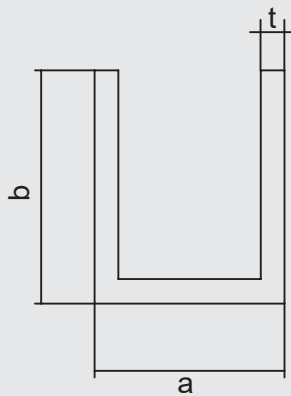

CODE	SIZE (A*B*T)	LGTH	AP	FINISH	MASS	GROUP ID
CH3218	25 x 25 x 3.0mm	6.5m	143	M/F CL/ANOD	0.543	18301 18301
CH3220	25 x 40 x 3.0mm	6.5m	204	M/F CL/ANOD	0.802	18301 18301
DT3223	24 x 24 x 1.2mm	6.5m	142	M/F CL/ANOD	0.227	18301 18301
DT3192	25 x 19 x 1.2mm	6.5m	124	M/F CL/ANOD	0.197	18301 18301
DT3355	16 x 16 x 1.6mm	6.5m	100	M/F CL/ANOD	0.186	18301 18301
GAZ003	22.4 x 25.4 x 1.3mm	6.5m	145	M/F CL/ANOD	0.213	18301 18301
GAZ004	25.4 x 25.4 x 1.3mm	6.5m	150	M/F CL/ANOD	0.221	18301 18301
CH3232	32 x 32 x 3.0mm	6.5m	211	M/F CL/ANOD	0.802	18301 18301
CH3245	32 x 45 x 3.0mm	6.5m	263	M/F CL/ANOD	1.026	18301 18301
CH1010T16	10 x 10 x 1.6mm	6.5m	100	M/F CL/ANOD	0.117	18301 18301
CH1212T10	12 x 12 x 1.0mm	6.5m	100	M/F CL/ANOD	0.092	18301 18301
CH1212T16	12 x 12 x 1.6mm	6.5m	100	M/F	0.140	18301
CH1616T16	16 x 16 x 1.6mm	6.5m	100	M/F	0.195	18301
CH2016T16	20 x 16 x 1.6mm	6.5m	101	M/F CL/ANOD	0.211	18301 18301
CH2020T16	20 x 20 x 1.6mm	6.5m	117	M/F	0.246	18301
CH2020T30	20 x 20 x 3.0mm	6.5m	114	M/F	0.437	18301
CH2525T16	25 x 25 x 1.6mm	6.5m	147	M/F	0.311	18301
CH3225T30	32 x 25 x 3.0mm	6.5m	158	M/F CL/ANOD	0.616	18301 18301
CH4025T30	40 x 25 x 3.0mm	6.5m	174	M/F CL/ANOD	0.680	18301 18301
CH4040T30	40 x 40 x 3.0mm	6.0m	233	M/F	0.923	18301
CH5025T30	50 x 25 x 3.0mm	6.5m	194	M/F CL/ANOD	0.761	18301 18301
CH8025T30	80 x 25 x 3.0mm	6.5m	253	M/F	1.004	18301
CH10050T30	100 x 50 x 3.0mm	6.5m	394	M/F CL/ANOD	1.577	18301 18301

• Please check with your local branch for stock availability



SQUARE TUBES

CODE	SIZE (A*B*T)	LGTH	AP	FINISH	MASS	GROUP ID
SQ1616T12	16 x 16 x 1.2mm	6.5m	100	M/F	0.249	18401
SQ1616T16	16 x 16 x 1.6mm	6.5m	100	M/F	0.249	18401
SQ1919T16	19 x 19 x 1.6mm	6.5m	100	M/F	0.301	18401
SQ2020T15	20 x 20 x 1.5mm	6.5m	100	M/F	0.318	18401
SQ2525T12	25 x 25 x 1.2mm	6.5m	100	M/F	0.308	18401
SQ2525T16	25 x 25 x 1.6mm	6.5m	100	M/F	0.404	18401
SQ2525T30	25 x 25 x 3.0mm	6.5m	100	M/F	0.710	18401
SQ3232T20	32 x 32 x 2.0mm	6.5m	128	M/F	0.648	18401
SQ3232T30	25 x 100 x 2.5mm	6.5m	128	M/F	0.940	18401
SQ4040T16	40 x 40 x 1.6mm	6.5m	160	M/F	0.664	18401
SQ4040T25	40 x 40 x 2.5mm	6.5m	160	M/F	1.013	18401
SQ4040T30	40 x 40 x 3.0mm	6.5m	160	M/F	1.199	18401
SQ4545T16	45 x 45 x 1.6mm	6.5m	180	M/F CL/ANOD	0.751	18401
SQ5050T15	50 x 50 x 1.6mm	6.5m	200	M/F	0.786	18401
SQ5050T16	50 x 50 x 1.6mm	6.5m	200	M/F	0.837	18401
SQ5050T25	50 x 50 x 2.5mm	6.5m	200	M/F CL/ANOD	1.283	18401
SQ5050T30	50 x 50 x 3.0mm	6.5m	200	M/F CL/ANOD	1.523	18401
SR1919T12	19 x 19 x 1.2mm	6.5m	100	M/F	0.231	18401
SR2525T30	25 x 25 x 3.0mm	6.5m	100	M/F	0.713	18401
SR381254	38.1 x 25.4 x 2.54mm	6.5m	124	M/F	0.802	18401
SR4040T16	40 x 40 x 1.6mm	6.5m	157	M/F	0.650	18401
SR5050T20	50 x 50 x 2.0mm	6.5m	189	M/F	0.986	18401
SR5050T30	50 x 50 x 3.0mm	6.5m	190	M/F	1.466	18401
SR100100T30	100 x 100 x 3.0mm	6.5m	386	M/F	3.088	18401

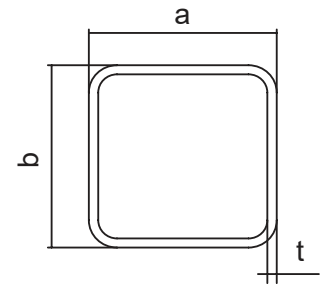
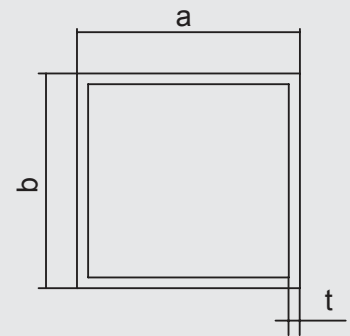

• Please check with your local branch for stock availability



RECTANGLE TUBES

CODE SIZE (A*B*T) LGTH AP FINISH MASS GROUP ID

SQ2540T25 40 x 25 x 2.5mm 6.5m 130 M/F 0.810 18501

SQ2550T30 50 x 25 x 3.0mm 6.5m 150 M/F 1.118 18501

SQ25100T25 25 x 100 x 2.5mm 6.5m 250 M/F 1.620 18501

SQ4080T30 40 x 80 x 3.0mm 6.5m 240 M/F 1.847 18501

SQ5080T30 50 x 80 x 3.0mm 6.5m 260 M/F 2.009 18501

SQ10025T25 100 x 25 x 2.5mm 6.5m 250 M/F 1.949 18501

SQ10050T16 100 x 50 x 1.6mm 6.5m 300 M/F 1.269 18501

SQ10050T30 100 x 50 x 3.0mm 6.5m 300 M/F 2.333 18501

SQ15050T30 150 x 50 x 3.0mm 6.5m 400 M/F 3.143 18501

SQ20050T30 200 x 50 x 3.0mm 6.5m 500 M/F 3.953 18501

SQ250100T40 250 x 100 x 4.0mm 6.5m 700 CL/ANOD 7.469 18501

SQ762254T24 76.2 x 25.4 x 2.4mm 6.5m 203 M/F 1.255 18501

SR2538T15 25 x 38 x 1.5mm 6.5m 121 M/F 0.470 18501

SR2538T16 25 x 38 x 1.6mm 6.5m 121 M/F 0.517 18501

SR4040T30 40 x 40 x 3.0mm 6.5m 155 M/F 1.188 18501

SR6565T30 65 x 65 x 3.0mm 6.5m 251 M/F 2.009 18501

SR4040T16 25 x 38 x 1.6mm 6.5m 155 M/F 1.188 18501

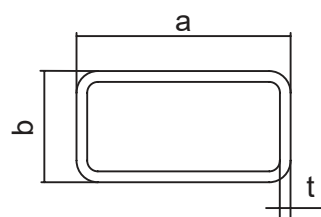
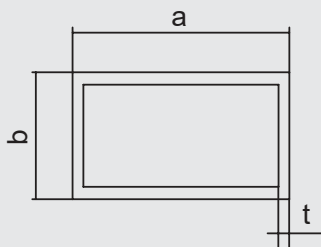

• Please check with your local branch for stock availability



ROUND TUBES & TEE SECTIONS

ROUND TUBES

CODE	SIZE (A*B*T)	LGTH	AP	FINISH	MASS	GROUP ID
RD10R12	10 x 1.2mm	6.5m	100	M/F	0.090	18601
RD12R16	12 x 1.6mm	VARIES	100	M/F	0.141	18601
RD16R12	16 x 1.2mm	6.5m	100	M/F	0.151	18601
RD16R16	16 x 1.6mm	6.5m	100	M/F	0.195	18601
RD19R12	19 x 1.2mm	6.5m	100	M/F	0.182	18601
RD19R16	19 x 1.6mm	6.5m	100	M/F	0.238	18601
RD25R16	25 x 1.6mm	6.5m	100	M/F	0.318	18601
RD25R30	25 x 3.0mm	6.5m	100	M/F	0.565	18601
RD32R16	32 x 1.6mm	6.5m	101	M/F	0.413	18601
RD32R30	32 x 3.0mm	6.5m	101	M/F	0.737	18601
RD38R30	38 x 3.0mm	6.5m	119	M/F	0.891	18601
RD40R30	40 x 3.0mm	6.5m	126	M/F	0.953	18601
RD50R16	50 x 1.6mm	6.5m	157	M/F	0.697	18601
RD50R30	50 x 3.0mm	6.5m	157	M/F	1.196	18601
RD60R20	60 x 2.0mm	6.5m	189	M/F	0.988	18601
RD60R30	60 x 3.0mm	6.5m	188	M/F	1.450	18601

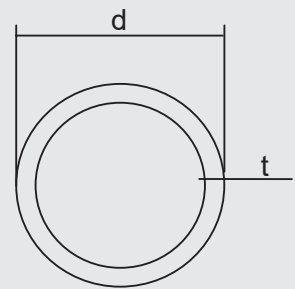

TEE SECTIONS

CODE	SIZE (A*B*T)	LGTH	AP	FINISH	MASS	GROUP ID
TS191916	19 x 19 x 1.6mm	6.5m	100	M/F	0.157	18701
TS252516	25 x 25 x 1.6mm	6.5m	100	M/F	0.209	18701
TS252530	25 x 25 x 3.0mm	6.5m	100	M/F	0.382	18701
TS363612	36 x 36 x 1.2mm	6.5m	144	M/F	0.230	18701
TS404016	40 x 40 x 1.6mm	6.5m	160	M/F	0.339	18701
TS404030	40 x 40 x 3.0mm	6.5m	160	M/F	0.626	18701

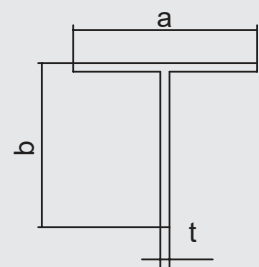

• Please check with your local branch for stock availability

