

GEOMETRIC SECTIONS

Angles

Angle (Thickness = 1.6 mm)245

Angle (Thickness = 3.0 mm+)246

Flat Bars..... 247

Channels 248

Square Tubes..... 249

Rectangle Tubes..... 250

Round Tubes 251

Tee Sections 251

ANGLES

THICKNESS = 1.6 MM

CODE	SIZE (A*B*T)	LGTH	AP	FINISH	MASS	GROUP ID
AN1212	12 x 12 x 1.6mm	6.5m	100	M/F CL/ANOD	0.097	18101
AN1225	12 x 25 x 1.6mm	6.5m	100	M/F CL/ANOD	0.154	18101
AN1240	12 x 40 x 1.6mm	6.5m	104	M/F CL/ANOD	0.219	18101
AN2012	20 x 12 x 1.6mm	6.5m	100	M/F CL/ANOD	0.132	18101
AN2020	20 x 20 x 1.6mm	6.5m	100	M/F CL/ANOD	0.165	18101
AN2025	20 x 25 x 1.6mm	6.5m	100	M/F CL/ANOD	0.187	18101
AN2032	20 x 32 x 1.6mm	6.5m	104	M/F CL/ANOD	0.219	18101
AN2040	20 x 40 x 1.6mm	6.5m	120	M/F CL/ANOD	0.252	18101
AN2050	20 x 50 x 1.6mm	6.5m	140	M/F CL/ANOD	0.294	18101
AN2525	25 x 25 x 1.6mm	6.5m	100	M/F CL/ANOD	0.209	18101
AN2532	25 x 32 x 1.6mm	6.5m	114	M/F CL/ANOD	0.234	18101
AN2540	25 x 40 x 1.6mm	6.5m	130	M/F CL/ANOD	0.275	18101
AN2550	25 x 50 x 1.6mm	6.5m	150	M/F CL/ANOD	0.317	18101
AN2570	25 x 70 x 1.6mm	6.5m	190	M/F CL/ANOD	0.405	18101
AN4040	40 x 40 x 1.6mm	6.5m	160	M/F CL/ANOD	0.338	18101
AN4070	40 x 70 x 1.6mm	6.5m	220	M/F	0.44	18101
AN5050	50 x 50 x 1.6mm	6.5m	200	M/F CL/ANOD	0.425	18101

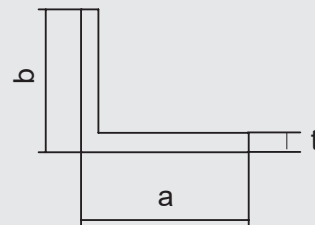

- Other powder-coated finishes may be available
- Please check with your local branch for stock availability



ANGLES

THICKNESS = 3.0 MM +

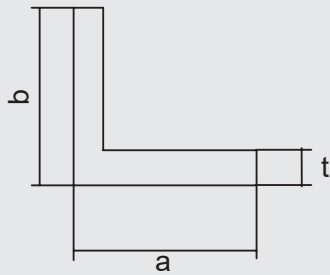

CODE	SIZE (A*B*T)	LGTH	AP	FINISH	MASS	GROUP ID
HAN2020	20 x 20 x 3mm	6.5m	100	M/F	0.3	18102
HAN2025	20 x 25 x 3mm	6.5m	100	M/F	0.341	18102
HAN2032*	20 x 32 x 3mm	6.5m	104	M/F	0.397	18102
HAN2080	20 x 80 x 3mm	6.5m	200	M/F	0.786	18102
HAN2525	25x 25 x 3mm	6.5m	100	M/F CL/ANOD	0.382	18102
HAN2540	25 x 40 x 3mm	6.5m	130	M/F	0.504	18102
HAN2550	25 x 50 x 3mm	6.5m	150	M/F	0.585	18102
HAN2570	25 x 70 x 3mm	6.5m	190	M/F	0.76	18102
HAN3232	32 x 32 x 3mm	6.5m	128	M/F	128	18102
HAN4040	40 x 40 x 3mm	6.5m	160	M/F	160	18102
HAN5050	50 x 50 x 3mm	6.5m	305	M/F CL/ANOD	1.21	18102
HAN50100*	50.8 x 101.6 x 3mm	6.5m	305	M/F	1.21	18102
HAN50125*	50 x 125 x 3mm	6.5m	350	M/F	1.393	18102
HAN5006	50 x 50 x 6mm	6.5m	200	M/F	1.527	18102
HAN8006*	80 x 80 x 6mm	6.5m	320	M/F	2.502	18102

- Available ex-Mill
- Please check with your local branch for stock availability



FLATBARS

CODE	SIZE (A*T)	LGTH	AP	FINISH	MASS	GROUP ID
FB1225	12 x 2.5mm	4.0m	100	M/F CL/ANOD	0.081	18201
FB2030	20 x 3.0mm	4.0m	100	M/F CL/ANOD	0.162	18201
FB2516	25 x 1.6mm	4.0m	100	M/F CL/ANOD	0.109	18201
		2.8m	100	M/F CL/ANOD	0.108	
FB2530	25 x 3.0mm	4.0m	100	M/F CL/ANOD	0.203	18201
FB2560	25 x 6.0mm	4.0m	100	M/F CL/ANOD	0.406	18201
FB3230	32 x 3.0mm	4.0m	100	M/F CL/ANOD	0.26	18201
FB4016	40 x 1.6mm	4.0m	100	M/F CL/ANOD	0.174	18201
FB4030	40 x 3.0mm	4.0m	100	M/F CL/ANOD	0.325	18201
FB4060	40 x 6.0mm	4.0m	100	M/F CL/ANOD	0.65	18201
FB5030	50 x 3.0mm	4.0m	106	M/F CL/ANOD	0.406	18201
FB5060	50 x 6.0mm	4.0m	112	M/F CL/ANOD	0.812	18201
FB5080	50 x 8.0mm	4.0m	100	M/F CL/ANOD	1.08	18201
FB50100	50 x 10mm	4.0m	120	M/F	0.35	18201
FB8030	80 x 3.0mm	4.0m	166	M/F CL/ANOD	0.648	18201
FB80100	80 x 10mm	4.0m	180	M/F CL/ANOD	2.16	18201
FB10016	100 x 1.6mm	3.6m	203	M/F CL/ANOD	0.433	18201
FB10030	100 x 3.0mm	4.0m	206	M/F CL/ANOD	0.812	18201
FB10060	100 x 6.0mm	4.0m	212	M/F	1.626	182.01
FB100100	100 x 10mm	4.0m	220	M/F CL/ANOD	2.7	18201
FB15018	150 x 1.8mm	3.6m	304	M/F CL/ANOD	0.729	18201

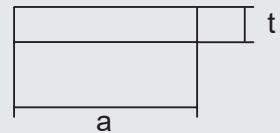

• Please check with your local branch for stock availability



CHANNELS

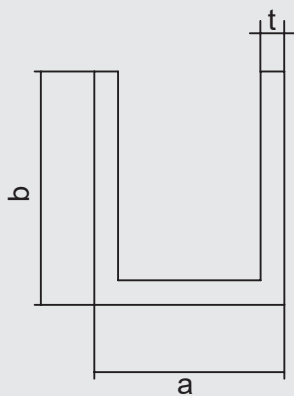

CODE	SIZE (A*B*T)	LGTH	AP	FINISH	MASS	GROUP ID
CH3218	25 x 25 x 3mm	6.5m	143	M/F CL/ANOD	0.543	18301 18301
CH3220	25 x 40 x 3mm	6.5m	204	M/F CL/ANOD	0.802	18301 18301
DT3223	24 x 24 x 1.2mm	6.5m	142	M/F CL/ANOD	0.227	18301 18301
DT3192	25 x 19 x 1.2mm	6.5m	124	M/F CL/ANOD	0.197	18301 18301
DT3355	16 x 16 x 1.6mm	6.5m	100	M/F CL/ANOD	0.186	18301 18301
GAZ003	22.4 x 25.4 x 1.3mm	6.5m	145	M/F CL/ANOD	0.213	18301 18301
GAZ004	25.4 x 25.4 x 1.3mm	6.5m	15	M/F CL/ANOD	0.221	18301 18301
CH3232	32 x 32 x 3mm	6.5m	211	M/F CL/ANOD	0.802	18301 18301
CH3245	32 x 45 x 3mm	6.5m	263	M/F CL/ANOD	1.026	18301 18301
CH1010T16	10 x 10 x 1.6mm	6.5m	100	M/F CL/ANOD	0.117	18301 18301
CH1212T10	12 x 12 x 1.0mm	6.5m	100	M/F CL/ANOD	0.092	18301 18301
CH1212T16	12 x 12 x 1.6mm	6.5m	100	M/F	0.14	18301
CH2016T16	20 x 16 x 1.6mm	6.5m	101	M/F CL/ANOD	0.211	18301 18301
CH2020T16	20 x 20 x 1.6mm	6.5m	117	M/F	0.246	18301
CH3225T30	32 x 25 x 3.0mm	6.5m	158	M/F CL/ANOD	0.616	18301 18301
CH4025T30	40 x 25 x 3.0mm	6.5m	174	M/F CL/ANOD	0.68	18301 18301
CH5025T30	50 x 25 x 3.0mm	6.5m	194	M/F CL/ANOD	0.761	18301 18301
H10050T30	100 x 50 x 3mm	6.5m	394	M/F CL/ANOD	1.577	18301 18301

• Please check with your local branch for stock availability



SQUARE TUBES

CODE	SIZE (A*B*T)	LGTH	AP	FINISH	MASS	GROUP ID
SQ1616T12	16 x 16 x 1.2mm	6.5m	100	M/F	0.249	18401
SQ1616T16	16 x 16 x 1.6mm	6.5m	100	M/F	0.249	18401
SQ1919T16	19 x 19 x 1.6mm	6.5m	100	M/F	0.301	18401
SQ2525T12	25 x 25 x 1.2mm	6.5m	100	M/F	0.308	18401
SQ2525T16	25 x 25 x 1.6mm	6.5m	100	M/F	0.404	18401
SQ2525T30	25 x 25 x 3.0mm	6.5m	100	M/F	0.71	18401
SQ3232T20	32 x 32 x 2.0mm	6.5m	128	M/F	0.648	18401
SQ4040T16	40 x 40 x 1.6mm	6.5m	160	M/F	0.664	18401
SQ4040T25	40 x 40 x 2.5mm	6.5m	160	M/F	1.013	18401
SQ4040T30	40 x 40 x 3.0mm	6.5m	160	M/F	1.199	18401
SQ4545T16	45 x 45 x 1.6mm	6.5m	180	M/F CL/ANOD	0.751	18401
SQ5050T15	50 x 50 x 1.6mm	6.5m	200	M/F	0.786	18401
SQ5050T25	50 x 50 x 2.5mm	6.5m	200	M/F CL/ANOD	1.283	18401
SQ5050T30	50 x 50 x 3.0mm	6.5m	200	M/F CL/ANOD	1.523	18401
SR1919T12	19 x 19 x 1.2mm	6.5m	100	M/F	0.231	18401
SR2525T30	25 x 25 x 3mm	6.5m	100	M/F	0.713	18401
SR381254	38.1 x 25.4 x 2.54mm	6.5m	124	M/F	0.802	18401
SR4040T16	40 x 40 x 1.6mm	6.5m	157	M/F	0.65	18401
SR5050T20	50 x 50 x 2.0mm	6.5m	189	M/F	0.986	18401
SR5050T30	50 x 50 x 3.0mm	6.5m	190	M/F	1.466	18401

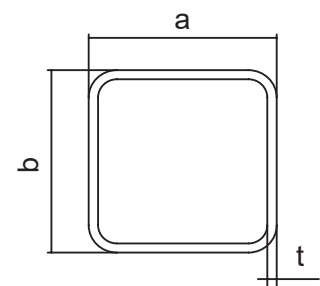
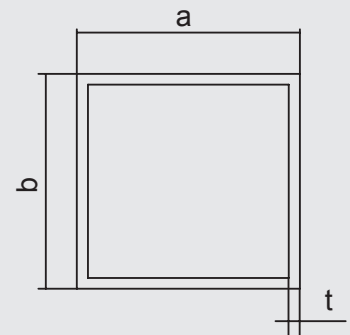

• Please check with your local branch for stock availability

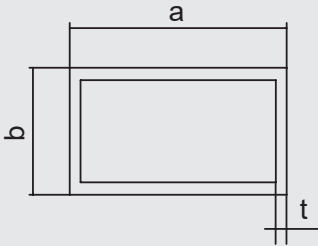
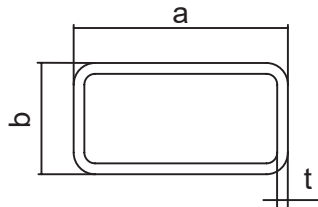

RECTANGLE TUBES

	CODE	SIZE (A*B*T)	LGTH	AP	FINISH	MASS	GROUP ID
	SQ2540T25	40 x 25 x 2.5mm	6.5m	130	M/F	0.81	18501
	SQ2550T30	50 x 25 x 3.0mm	6.5m	150	M/F	1.118	18501
	SQ4080T30	40 x 80 x 3.0mm	6.5m	240	M/F	1.847	18501
	SQ5080T30	50 x 80 x 3.0mm	6.5m	260	M/F	2.009	18501
	SQ10025T30MF65	100 x 25 x 3.0mm	6.5m	250	M/F	1.949	18501
	SQ10050T16	100 x 50 x 1.6mm	6.5m	300	M/F	1.269	18501
	SQ10050T30	100 x 50 x 3.0mm	6.5m	300	M/F	2.333	18501
	SQ15050T30	150 x 50 x 3.0mm	6.5m	400	M/F	3.143	18501
	SQ20050T30	200 x 50 x 3.0mm	6.5m	500	M/F	3.953	18501
	SQ762254T24	76.2 x 25.4 x 2.4mm	6.5m	203	M/F	1.255	18501
	SR2538T15	25 x 38 x 1.5mm	6.5m	121	M/F	0.47	18501
	SR2538T16	25 x 38 x 1.6mm	6.5m	121	M/F	0.517	18501
	SR6565T30MF65	65 x 65 x 3.0mm	6.5m	251	M/F	2.009	18501
	SR4040T30MF65	25 x 38 x 1.6mm	6.5m	155	M/F	1.188	18501

• Please check with your local branch for stock availability



ROUND TUBES & TEE SECTIONS

ROUND TUBE

CODE	SIZE (A*B*T)	LGTH	AP	FINISH	MASS	GROUP ID
RD12R16	12 x 1.6mm	VARIABLES	100	M/F	0.141	18601
RD16R12	16 x 1.2mm	6.5m	100	M/F	0.151	18601
RD16R16	16 x 1.6mm	6.5m	100	M/F	0.195	18601
RD19R12	19 x 1.2mm	6.5m	100	M/F	0.182	18601
RD19R16	19 x 1.6mm	6.5m	100	M/F	0.238	18601
RD25R16	25 x 1.6mm	6.5m	100	M/F	0.318	18601
RD25R30	25 x 3.0mm	6.5m	100	M/F	0.565	18601
RD32R16	32 x 1.6mm	6.5m	101	M/F	0.413	18601
RD32R30	32 x 3.0mm	6.5m	101	M/F	0.737	18601
RD40R30	40 x 3.0mm	6.5m	126	M/F	0.953	18601
RD50R16	50 x 1.6mm	6.5m	157	M/F	0.697	18601
RD50R30	50 x 3.0mm	6.5m	157	M/F	1.196	18601
RD60R20	60 x 2.0mm	6.5m	189	M/F	0.988	18601

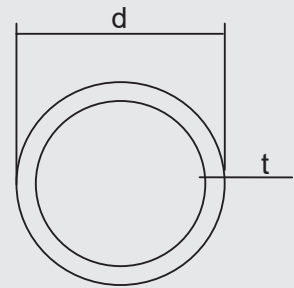

TEE SECTION

CODE	SIZE (A*B*T)	LGTH	AP	FINISH	MASS	GROUP ID
TS191916	19 x 19 x 1.6mm	6.5m	100	M/F	0.157	18701
TS252516	25 x 25 x 1.6mm	6.5m	100	M/F	0.209	18701
TS252530	25 x 25 x 3.0mm	6.5m	100	M/F	0.382	18701
TS363612	36 x 36 x 1.2mm	6.5m	144	M/F	0.23	18701
TS404016	40 x 40 x 1.6mm	6.5m	160	M/F	0.339	18701
TS404030	40 x 40 x 3.0mm	6.5m	160	M/F	0.626	18701

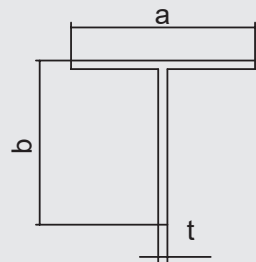

• Please check with your local branch for stock availability

