

INDUSTRIAL PRODUCTS

Rolled Products

Aluminium Sheet.....	253
Aluminium Plate.....	253
Tread Plate.....	253

Darley Work Planks.....	254
--------------------------------	------------

Seat Sections.....	255
---------------------------	------------

Sign Box.....	255
----------------------	------------

Cool Room Sections.....	256
--------------------------------	------------

Miscellaneous Sections.....	257
------------------------------------	------------

ROLLED PRODUCTS

ALUMINIUM SHEET

CODE	SIZE (W*L*T)	FINISH	GROUP ID
SH1224T12	1200 x 2400 x 1.2mm	M/F CL/ANOD	20101
SH1224T16	1200 x 2400 x 1.6mm	M/F CL/ANOD	20101
SH1224T20	1200 x 2400 x 2.0mm	M/F CL/ANOD	20101
SH1224T30	1200 x 2400 x 3.0mm	M/F CL/ANOD	20101
SH1224T60	1200 x 2400 x 6.0mm	M/F CL/ANOD	20101
SH1230T12	1200 x 3000 x 1.2mm	M/F CL/ANOD	20101
SH1230T16	1200 x 3000 x 1.6mm	M/F CL/ANOD	20101
SH1230T20	1200 x 3000 x 2.0mm	M/F CL/ANOD	20101
SH1230T30	1200 x 3000 x 3.0mm	M/F CL/ANOD	20101
SH1236T12	1200 x 3600 x 1.2mm	M/F CL/ANOD	20101
SH1236T16	1200 x 3600 x 1.6mm	M/F CL/ANOD	20101
SH1236T20	1200 x 3600 x 2.0mm	M/F CL/ANOD	20101
SH1236T30	1200 x 3600 x 3.0mm	M/F CL/ANOD	20101

ALUMINIUM PLATE

CODE	SIZE (W*L*T)	FINISH	GROUP ID
PL1224T40	1200 x 2400 x 4.0mm	M/F	20101
PL1224T50	1200 x 2400 x 5.0mm	M/F	20101
PL1224T60	1200 x 2400 x 6.0mm	M/F	20101

TREAD PLATE

CODE	SIZE (W*L*T)	FINISH	GROUP ID
TP5-1224T16	1200 x 2400 x 1.6mm	M/F	20101
TP5-1224T20	1200 x 2400 x 2.0mm	M/F	20101
TP5-1224T25	1200 x 2400 x 2.5mm	M/F	20101
TP5-1224T30	1200 x 2400 x 3.0mm	M/F	20101
TP5-1224T40	1200 x 2400 x 4.0mm	M/F	20101
TP5-1224T50	1200 x 2400 x 5.0mm	M/F	20101
TP5-1224T60	1200 x 2400 x 6.0mm	M/F	20101
TP5-1230T25	1200 x 3000 x 2.5mm	M/F	20101
TP5-1524T16	1500 x 2400 x 1.6mm	M/F	20101

• Please check with your local branch for stock availability

DARLEY WORK PLANKS

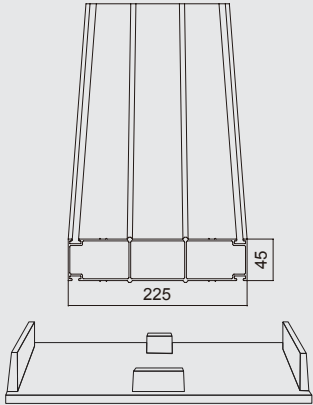
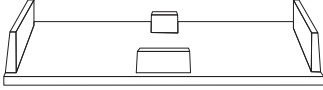
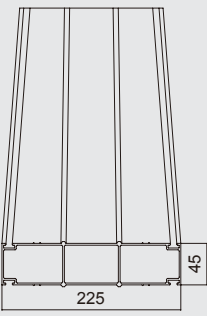
	CODE	DESCRIPTION	LGTH	FINISH	GROUP ID
	TJ900C	Work Plank (Complete)	3.0m	M/F	21101
			4.0m	M/F	21101
			5.0m	M/F	21101
			6.0m	M/F	21101
	EC-900	End Cap (Available ex-Mill)	Each	M/F	21101
	TJ900E	Work Plank • (Extrusion Only) • (Available ex-Mill)	Vari- ous	M/F	21101

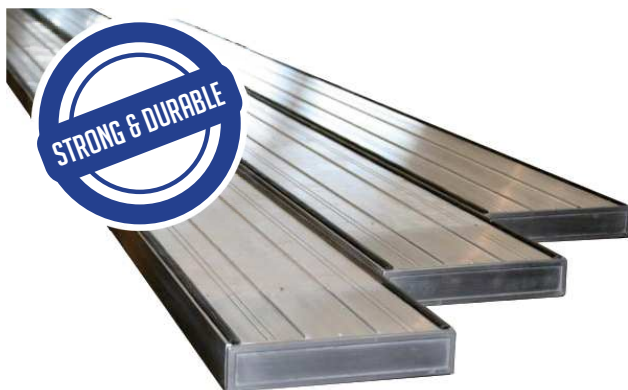

- The Darley Work Plank has been tested and approved by an independent NATA accredited laboratory.
- It has passed Stiffness, Strength, Sliding and Slip Tests to the Australian Standard AS1557-1993.

Maximum design span of 2500mm and a working load limit (WLL) of 2.06 kN (210KG); anti-slip rubber inserted on both sides.

SEAT SECTIONS & SIGN BOX

SEAT SECTIONS

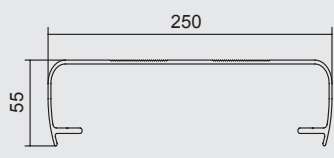
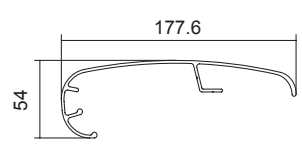
CODE	DESCRIPTION	LGTH	FINISH	GROUP ID	
SS2327	Seat	6.5m	M/F	21301	
SS2962	Back Rest	6.5m	M/F	21301	

SIGN BOX

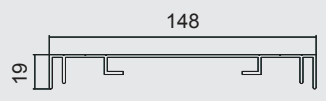
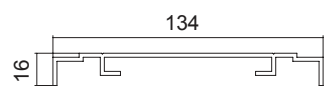

CODE	DESCRIPTION	LGTH	FINISH	GROUP ID	
SGN001	148mm Sign Box	6.0m	M/F	21001	
SGN002	134mm Sign Box	6.0m	M/F	21001	

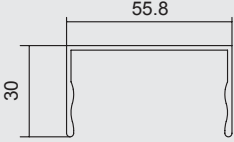
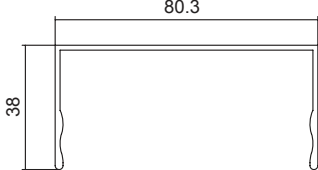
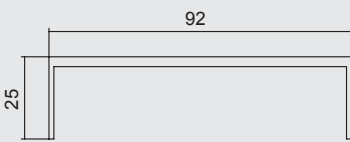
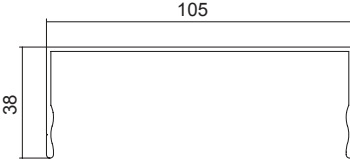
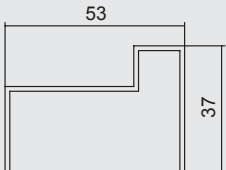
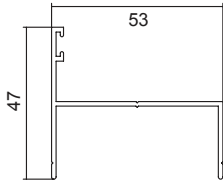
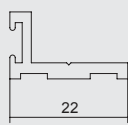
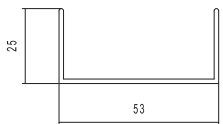

COOL ROOM SECTIONS

	CODE	DESCRIPTION	LGTH	FINISH	GROUP ID	LOC.
	CS100	Cool Room Channel 55.8 x 30mm	6.5m	M/F	21302	N W
	CS106	Cool Room Channel 80 x 38mm	6.5m	M/F	21302	N W
	CS107	Cool Room Channel 92 x 25mm	6.5m	M/F	21302	N W
	CS109	Cool Room Channel 105 x 3mm	6.5m	M/F	21302	N W
	CS121	Cool Room Door Jamb	6.5m	M/F	21302	N W
	CS122	Cool Room Door Jamb	6.5m	M/F	21302	N W
	CS123	Cool Room Door Stop	6.5m	M/F	21302	N W
	CS124	Cool Room Channel 53 x 25mm	6.5m	M/F	21302	N W

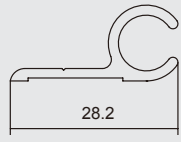
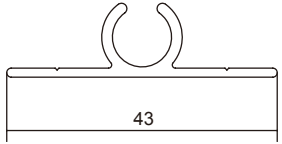
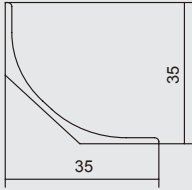
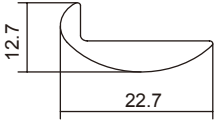
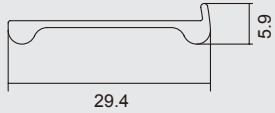
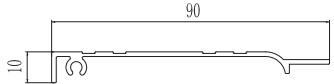
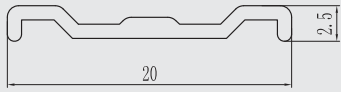
MISCELLANEOUS SECTIONS

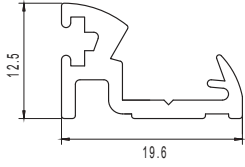
CODE	DESCRIPTION	LGTH	FINISH	GROUP ID	
GA101	Single Annex / Sail Track	6.0m	M/F	21301	
GA102	Double Sided Rope Track	6.0m	M/F	21301	
MC100	35mm Corner Mould	6.0m	M/F	21301	
MC120	Table Edge	6.0m	M/F	21301	
MC121	Table Edge	4.0m	M/F	21301	
KW038	90mm Architrave	6.0m	M/F	17301	
RWM046	Colonial Bar	4.3m	M/F	17296	
TJ773	Plant On Door Stop  1600, 1601	6.5	M/F CL/ANOD	9701 9702	

MISCELLANEOUS SECTIONS

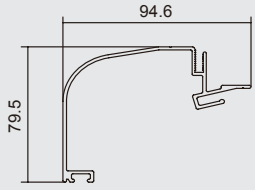
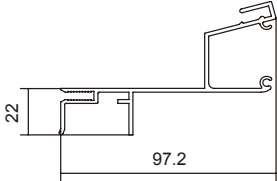
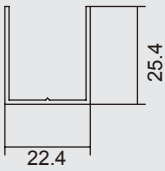
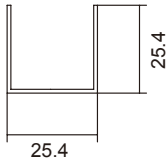
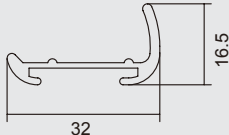
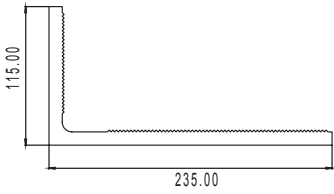
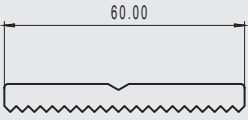
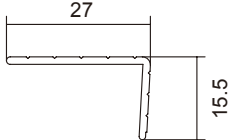
CODE	DESCRIPTION	LGTH	FINISH	GROUP ID	
GAZ001	Pop Up Canopy	5.0m	M/F	21201	
GAZ002	Pop Up Roof Frame	5.0m	M/F	21201	
GAZ003	Channel	6.8m	M/F	21201	
GAZ004	Channel	6.8m	M/F	21201	
GAZ005	Cover Strip	6.0m	M/F	21201	
DCW027	Bracket <i>(Special order only)</i>	3.0m	Black	12001	
DCW028	Washer <i>(Special order only)</i>	6.5m	Black	12001	
GAZ007	Trim Angle	4.0m	M/F	21201	

SPECIAL
FEATURE

dormakaba 

Dormakaba offers innovative solutions for building & door openings, security and access control for a wide range of industries. Trusted by builders, fabricators, architects and designers, Dormakaba has a reputation for product reliability and impeccable customer service. Check out some of their latest products below or speak to your Account Manager about other products.



ST9212 SERIES MORTICE LOCK KITS

- 23mm backset
- 316 stainless steel latch, dead latching bolt, face plate and striker plate as standard
- Nickel plated zinc alloy case
- Anti-lockout function as standard, that can easily be engaged or disengaged
- 316 stainless steel furniture as standard in kits
- Includes cylinders

DARLEY CODE ITEM DESCRIPTION

1191	ST9212 Lock Kit - double cylinder entry lock with 23mm backset
1192	ST9212 Office lock Kit - cylinder and turn with 23mm backset
1193	ST9212 Classroom lock Kit - external cylinder with 23mm backset



950/951 SERIES SHORT BACKSET MORTICE DEADLOCKS

- Suits narrow stile door sections with 28mm internal thickness and 58mm external thickness
- 23mm backset
- Standard Kaba 130 type oval cylinder with M616 cam
- 22mm, 28mm & 37mm projection bolt

DARLEY CODE ITEM DESCRIPTION

1197	Dormakaba 950 lock body 22mm bolt, incl 2 Escutcheons, C4 Cyl and C/F Turn
1198	Dormakaba 950 Lock Body 37mm bolt, incl 2 Escutcheons, C4 Cyl and C/F Turn
1199	Dormakaba 951 Lock Body 29 mm hook bolt, incl 2 Escutcheons, C4 Cyl and C/F Turn
1194	Dormakaba 950 Lock body 22mm bolt, incl 2 Escutcheons and C4 Cylinders
1195	Dormakaba 950 Lock Body 37mm bolt, incl 2 Escutcheons and C4 Cylinders
1196	Dormakaba 951 Lock body 29mm hook bolt, incl 2 Escutcheons and C4 Cylinders



TS77 DOOR CLOSER

- TS77 door closer is very quick and easy to install
- Choice of three strengths
- Door widths up to 1100mm with backcheck function
- Outstanding value for money
- Includes Parallel Arm Bracket as standard

DARLEY CODE ITEM DESCRIPTION

1072-2	Dormakaba TS77 Standard Arm and back check Size 2 closer(40kg) Silver
1072-3	Dormakaba TS77 Standard Arm and back check Size 3 closer (60 kg)Silver
1072-4	Dormakaba TS77 Standard Arm and Back Check Size 4 closer (80 kg) Silver