

EASY PICKET

A STYLISH AND DURABLE ALUMINIUM FENCING SYSTEM



EASY PICKET

PRODUCT FEATURES

The Darley Aluminium Easy Picket system is an attractive concealed fixing solution for all your screening and fencing needs. Easy to install, this powder coated aluminium product is designed to last in harsh environments.

A versatile system comprising of a suite of aluminium extrusions and plastics that provide a complete screening solution, which can be used in both commercial and residential applications.

CONCEALED FIXING

Easy Picket is a concealed fixing system, designed to hide unsightly screws and rivets. This unique concealed system is not only easy-to-install, it also doesn't require any welding and gives your fencing & gate products a modern attractive look.

KEY BENEFITS

- Picket fence option - also with concealed fixing
- Optional assembly methods for pickets
- Wide range of colours* available
- Plastic or metal corner stakes available
- Low maintenance
- Easy to fabricate and install
- Flexible fence and gate configurations
- Resistant to warping, cracking and splintering
- Lasts longer than timber products
- Universal caps available
- Dedicated End Caps
- Available in blade widths of 38mm, 65mm, 75mm and 100mm.



APPLICATIONS

- Fencing & gates
- Sunscreens
- Privacy screening
- Area dividers
- Equipment enclosures

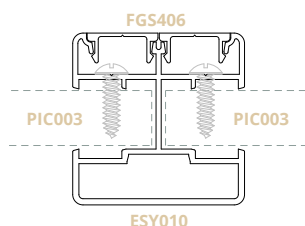

TOP VIEW

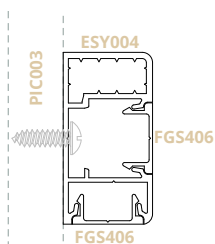

SIDE VIEW

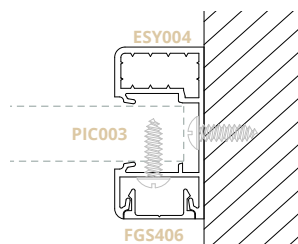

TOP VIEW

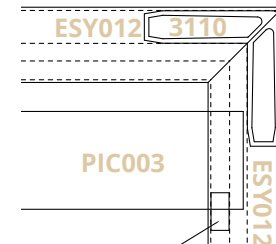

FRONT VIEW

Designed to last in harsh environments.

ALUMINIUM FENCING SYSTEM

EASY-TO-INSTALL

Unlike other systems, Darley's Easy Picket system is easy to fabricate and install with sections that can be assembled and screwed together on site or in the factory. It can easily accommodate different blade widths and can provide adjustable slat spacings when required.

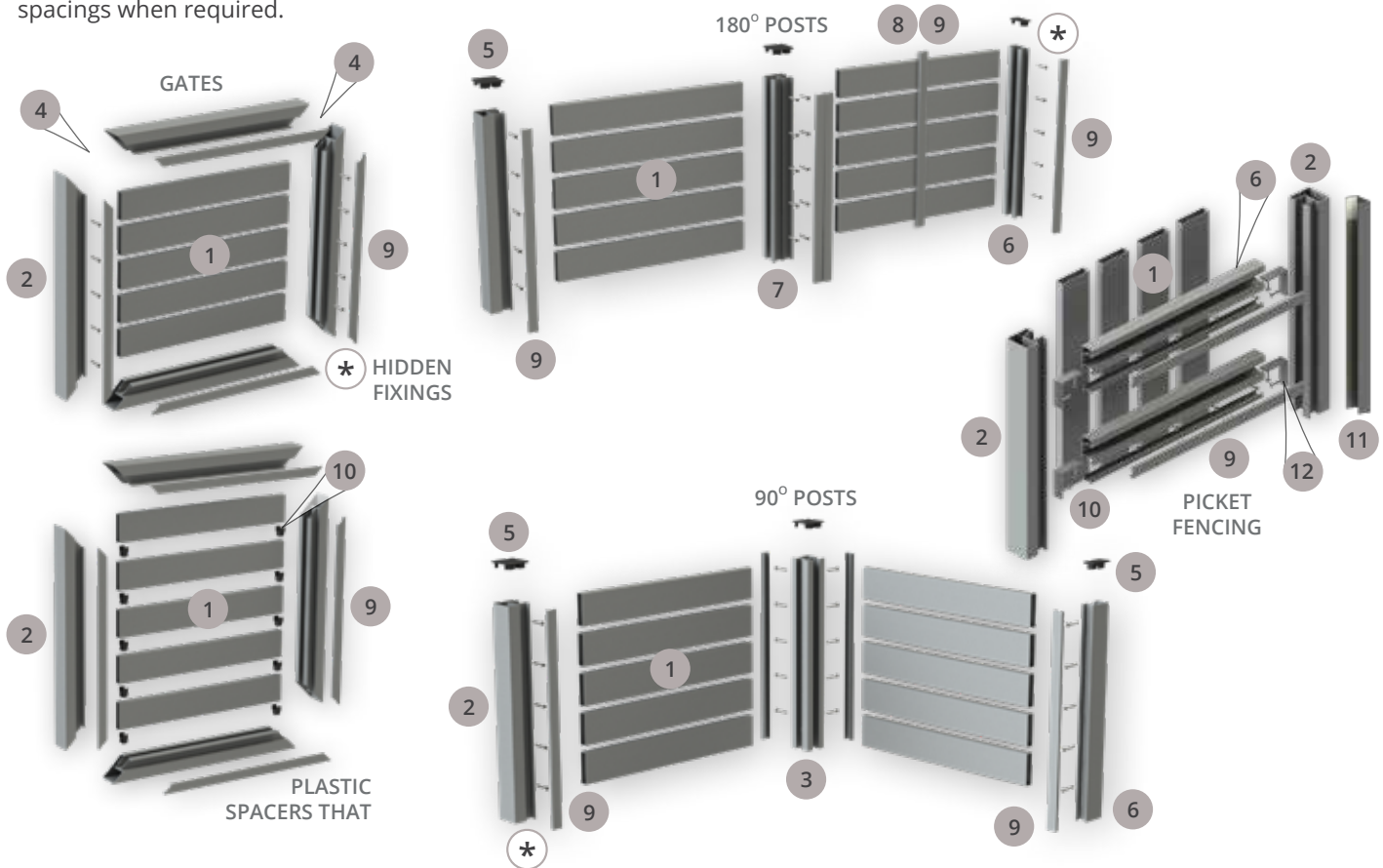

PICKET SECTIONS

CODE	DESCRIPTION
1	PIC001/PIC002/PIC003/ PIC012/PIC013 or PIC014
2	ESY009 or ESY012
3	ESY011
4	3110
5	3113
6	ESY004
7	ESY010
8	ESY005
9	FGS406
10	3114
11	CS100 or TJ325
12	1860
*	-

HARDWARE

4 HINGE OPTIONS AVAILABLE

3231	Neutral tension gate hinge, with legs
3232	Fixed tension gate hinge, 1 leg
3233	Adjusted tension hinge, with legs
3234	Adjusted tension hinge

^ Alternative hinges available on request for a range of applications.

3241	Trilatch 25cm short gate latch
3244	Trilatch 127cm long gate latch
3242	Viper gravity latch - single sided
3243	Viper gravity latch - double sided
3251	Gate handle

^ Latches and handles available to suit a range of applications.

3211	Metal top black
3217	Windsor spear cap
3213	90x90 square top cap
3212	Metal brace bracket

ALUMINIUM LOUVRE SYSTEM

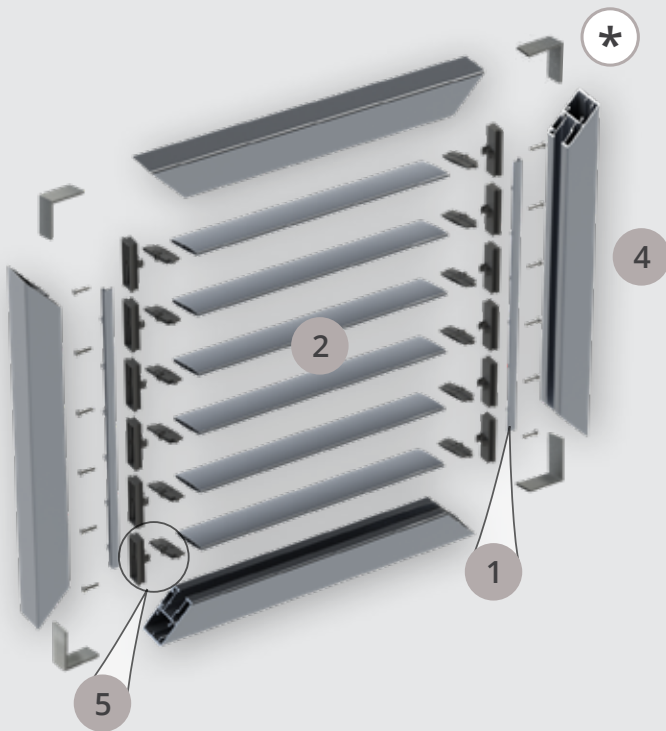

ORLEANES

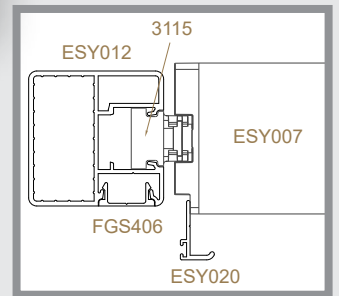

Cross Section



LORRAINE

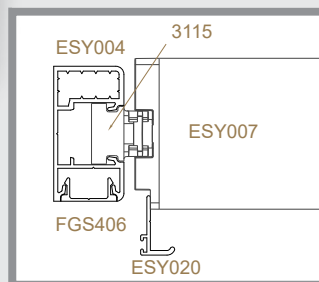
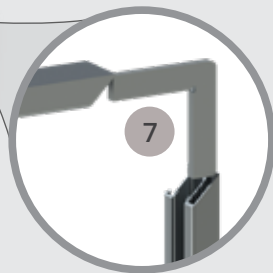

Cross Section

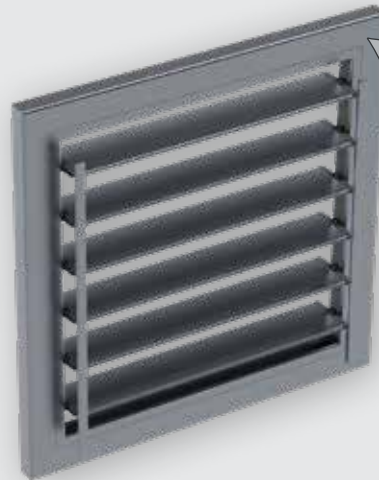

SARTHE

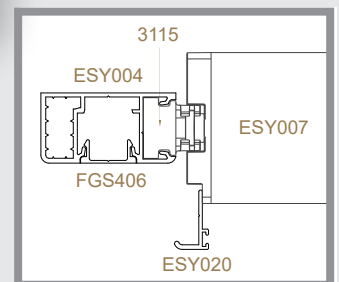
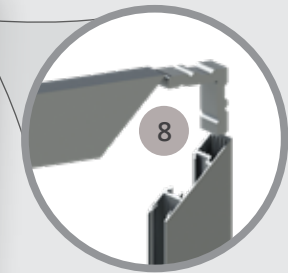

Cross Section

LOUVRE SECTIONS

CODE	DESCRIPTION
1	ESY020 Louvre Control Bar
2	ESY007 70mm Elliptical Blade
3	ESY004 Jamb Horizontal
4	ESY009 Picket Post Single Side

HARDWARE

CODE	DESCRIPTION
5	3115 Louvre Insert Set
6	3110 Orleanes Louvre Corner Stake
7	1823 Lorraine Louvre Corner Stake
8	5002 Sarthe Louvre Corner Stake
*	6, 7 or 8, see configs

PROFILES

PICKET PROFILES

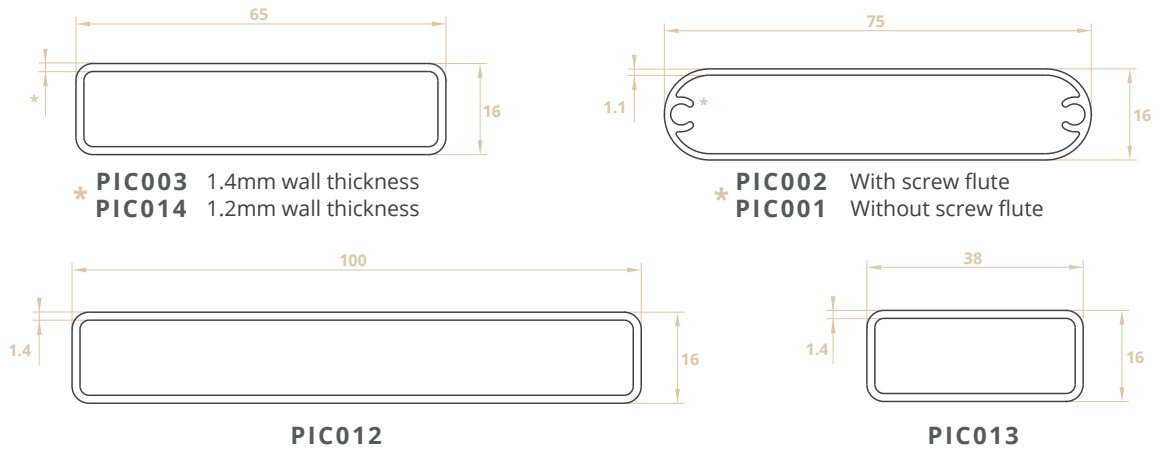

MULTI-FUNCTIONAL PROFILES

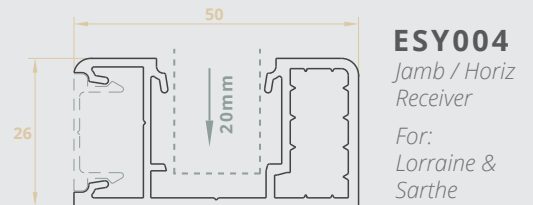
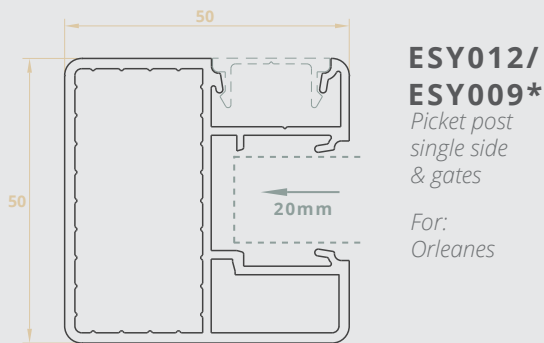

FENCING PROFILES

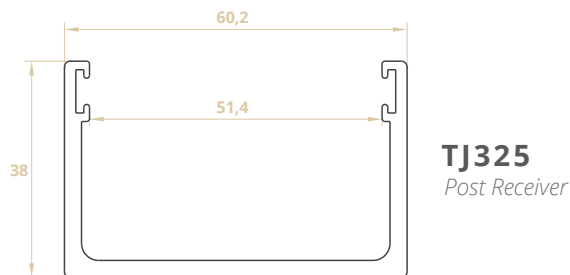
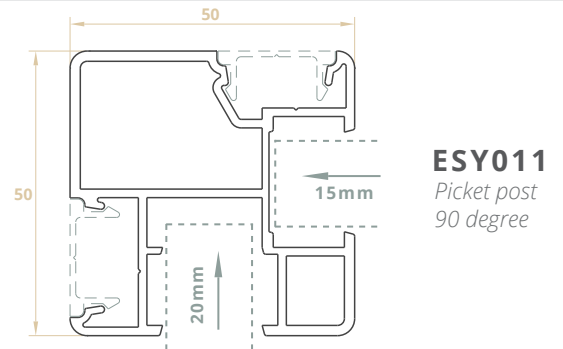
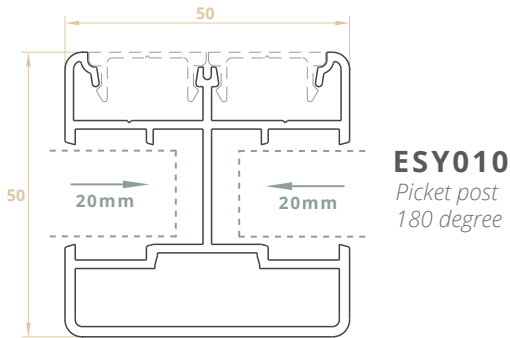

LOUVRE PROFILES



HARDWARE



3114

EASY PICKET SPACER BLOCK

- Dual purpose spacer grips pickets during install
- Non-reactive material
- 12mm spacer (24mm when stacked)
- Black/white finish that hides inside the post



3110

CORNER STAKE SUITS ESY012

FOR GATES AND LOUVRES



3217

WINDSOR SPEAR CAP SUITS PIC012 ONLY

(MILL FINISH)



3218

END CAP PICKET

SUITS PIC003 & PIC012



1860

HORIZONTAL BRACE BRACKET

SUITS PICKET FENCE



3113

50 x 50 TOP CAP WITH BREAK-OFF

For use with ESY004 half post break in two.



3213

90 x 90 POST PLASTIC SQUARE TOP CAP

SUITS SQF9090T20 (BLACK)



3211

50 x 50 POST METAL TOP CAP

(BLACK)



3212

50 x 50 POST METAL BASE BRACKET (BLACK)



3215

POST BASE COVER SUITS ESY012

Coming Soon

POST BASE SUITS ESY012



3115

LOUVRE BLADE FITTING KIT

SUITS ESY012 & ESY004

(BLACK/WHITE)

1823

CORNER STAKE SUITS ESY004 FOR LORRAINE

5002

CORNER SUITS ESY004 FOR SARTHE

BIFOLD HARDWARE

3304 BIFOLD BARREL BOLT



3310 GUIDE



3307 HANGER

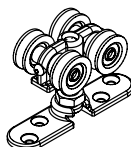

3309 HINGE

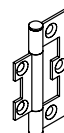

15401 FLSUH PULL

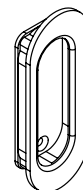

3308 PIVOT

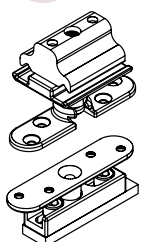

HARDWARE

HINGES & LATCHES

Safetech is a global leader in the manufacture of door lock hardware manufacturing some of the safest leading-edge hardware products. Made using the finest materials including fibre re-inforced quality polymers, aluminium and stainless steel, SafeTech hinges and latches have a lifetime warranty and are regularly tested by NATA accredited laboratories.



NEUTRAL TENSION GATE HINGE

(3231)

Colours available: Black
Holding Weight: 28kg



FIXED TENSION GATE HINGE

(3232)

Colours available: Black
Holding Weight: 28kg
Closing Weight: 15kg



ADJUSTABLE TENSION HINGE NO LEGS

(3234)

Colours available: Black
Holding Weight: 70kg
Closing Weight: 45kg



ADJUSTABLE TENSION HINGE WITH LEGS

(3233)

Colours available: Black
Holding Weight: 70kg
Closing Weight: 45kg



TRILATCH 25CM SHORT GATE LATCH

(3241)

Adjustment: Horizontal & Vertical
Colours available: Black



TRILATCH 127MM LONG GATE LATCH

(3244)

Adjustment: Horizontal & Vertical
Colours available: Black



GRAVITY SINGLE LATCH

(3242)

Adjustment: Horizontal & Vertical
Colours available: Black



VIPER GRAVITY DOUBLE LATCH

(3243)

Adjustment: Horizontal & Vertical
Colours available: Black



GATE HANDLE

(3251)

Colours available: Black
Easy to install
Elegant design

Designed to last in harsh environments.

WIDE RANGE OF COLOUR AND FINISH OPTIONS

Darley's Easy Picket system can be powdercoated using a large range of Dulux & Interpon colours. The colours listed below are some of the colours available, speak to your Darley Sales Representative about colour availability and powdercoat lead times.*

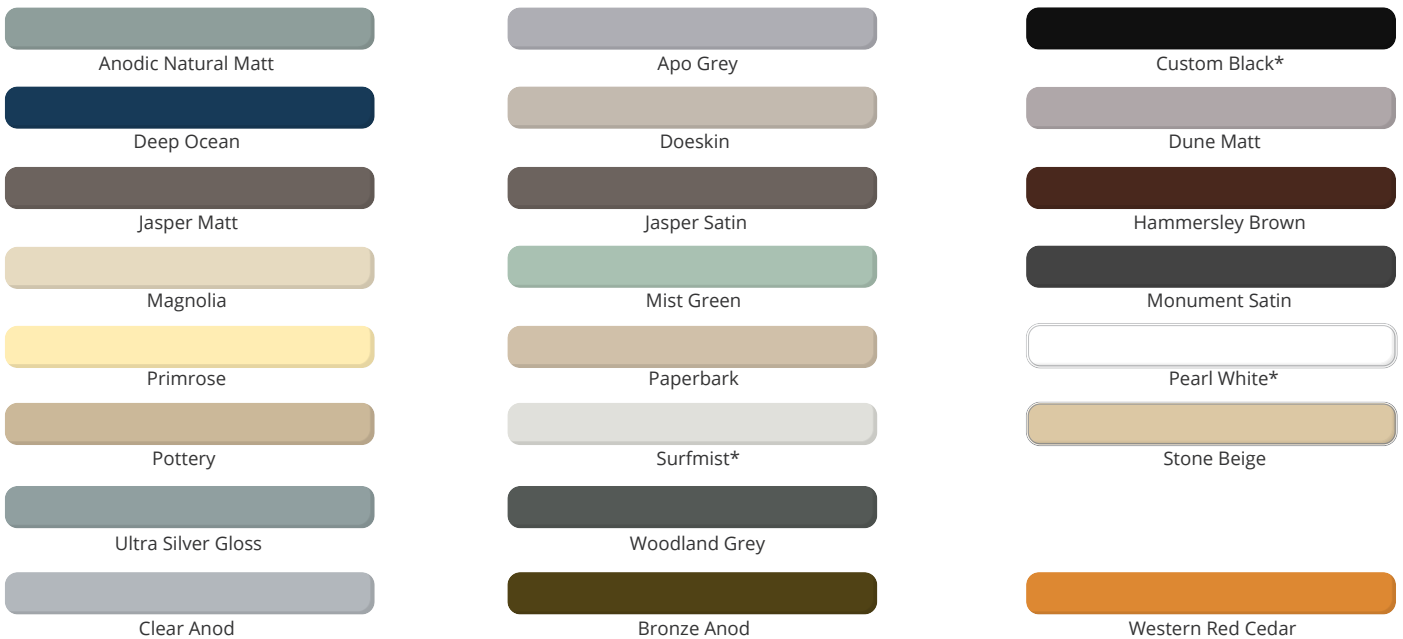

Darley Aluminium in WA stock easy picket sections in these colours & Mill Finish.*



10 YEAR WARRANTY

A 10 year warranty applies, from the date of installation.

SYDNEY HEAD OFFICE

8 Tyrone Place
Erskine Park NSW 2759
T: (02) 8887 2888
F: (02) 9834 3244

E: sales@darleyaluminium.com.au

MELBOURNE

10 Bridge Road
Keysborough VIC 3173
T: (03) 9238 3888
F: (03) 9768 7288

E: salesvic@darleyaluminium.com.au

BRISBANE

29 Access Avenue
Yatala QLD 4207
T: (07) 3287 1888
F: (07) 3287 2088

E: salesqld@darleyaluminium.com.au

PERTH

36 Armstrong Road
Hope Valley WA 6165
T: (08) 9437 2999
F: (08) 9437 1024

E: saleswa@darleyaluminium.com.au

